



# Installation Instructions Cable Bikini Top

Vehicle Application:  
Jeep® Wrangler Unlimited JL 2018-Current  
Part Number 52608

## Installation Tips

Before you begin installing your new Cable Bikini Top, please read all the instructions thoroughly.













**WARNING** Do not rely in any way on the components of this product to protect against injury or death in the event of an accident. Never operate the vehicle in excess of manufacturer's specifications.

Read and follow, precisely, all installation instructions provided when installing this product. Failure to do so may result in a poor fit and could place occupants of the vehicle in a potentially dangerous situation.



## WEAR SEAT BELTS AT ALL TIMES

**CAUTION** Safety glasses should be worn at all times when installing this product.

Tools		Installation Time	Support
 Safety Glasses	 T25 - T40 - T50 Torx Drivers	 <b>30 minutes</b>	We're here to help! Go to: <a href="https://www.bestop.com">https://www.bestop.com</a> and click on <b>Need Help?</b>
 Phillips Screw Driver	  - OR -  Ratchet      13mm Socket      13mm Wrench	<b>Skill Level</b>     <b>1 - Easy</b>	
		 <a href="https://www.bestop.com/video-library">https://www.bestop.com/video-library</a>	



## Installation Instructions Cable Bikini Top

Vehicle Application:  
Jeep® Wrangler Unlimited JL 2018-Current  
Part Number 52608

### Sugerencias de Instalación

**Antes de empezar a instalar esta unidad, lea atentamente todas las instrucciones.**

#### Para un buen ajuste:

Para facilitar la instalación, el producto debe instalarse a temperaturas superiores a 72 °F (22 °C).

Por debajo de esta temperatura, la tela puede encogerse una pulgada o más, lo que dificultaría su ajuste al vehículo.

Es normal que la tela se contraiga o arrugue cuando está guardada en la caja de empaque. A los pocos días después de la instalación, la tela se relajará y las arrugas desaparecerán.



#### ADVERTENCIA

Este producto se diseñó principalmente para mejorar la apariencia del vehículo y proteger a los ocupantes de las condiciones climáticas comunes. De ninguna manera piense que los componentes de este producto pueden servir como medio de contención para los ocupantes del vehículo o que pueden protegerlos contra lesiones o la muerte en caso de accidente. Este producto no protegerá a los ocupantes contra caídas de objetos. Nunca conduzca este vehículo fuera de las especificaciones del fabricante.

#### USE LOS CINTURONES DE SEGURIDAD EN TODO MOMENTO

Lea y siga con precisión todas las instrucciones de instalación que se proporcionan para instalar este producto. Si no lo hace, podría producirse un mal ajuste que colocaría a los ocupantes del vehículo en una situación potencialmente peligrosa.



#### PRECAUCIÓN

Debe usar gafas protectoras en todo momento durante la instalación de este producto.

### Conseils pour l'installation

**Lire toutes les instructions au complet avant de commencer l'installation de cet assemblage.**

#### Pour un ajustement sans problème :

Afin de faciliter l'installation, ce produit doit être installé à des températures au-dessus de 72 °F (22 °C).

Sous cette température, le tissu peut rétrécir d'un pouce (2,5 cm) ou plus, ce qui rendra l'ajustement sur le véhicule difficile.

Il est normal que le tissu rétrécisse et plisse pendant qu'il est dans la boîte d'expédition. En quelques jours après l'installation, le tissu se détendra et les plis disparaîtront.



#### AVERTISSEMENT

Ce produit est conçu principalement pour améliorer l'apparence du véhicule et pour protéger les occupants des conditions météorologiques usuelles. Ne jamais se fier aux composants de ce produit pour se protéger de blessures ou de la mort en cas d'accident. Ce produit ne protégera pas les occupants des chutes d'objets. Ne jamais utiliser le véhicule au-delà des caractéristiques techniques indiquées par le fabricant.

#### PORTER UNE CEINTURE DE SÉCURITÉ EN TOUT TEMPS

Lire et suivre, très fidèlement, toutes les instructions d'installation fournies lors de l'installation de ce produit. Ne pas suivre cette consigne peut causer une installation inadéquate et mettre les occupants du véhicule dans une situation potentiellement dangereuse.



#### MISE EN GARDE

Des lunettes de sécurité doivent être portées en tout temps lors de l'installation de ce produit.







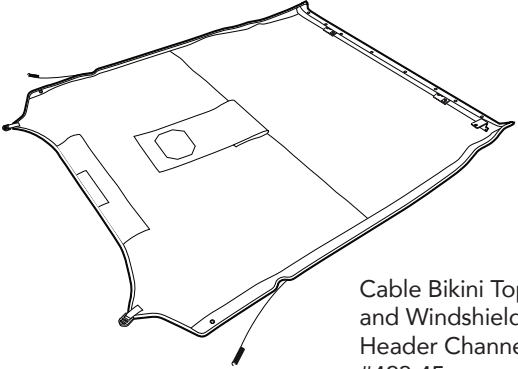
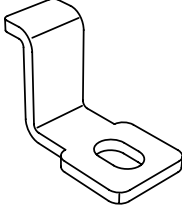
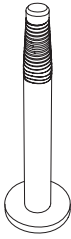
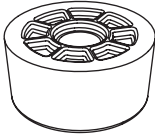
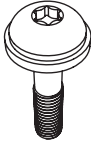

# Installation Instructions Cable Bikini Top

Vehicle Application:  
Jeep® Wrangler Unlimited JL 2018-Current  
Part Number 52608

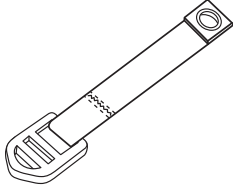
## Parts List

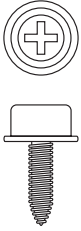
- Required parts for installation - Page number in Installation Guide

Sections 1 to 2		Bikini Top/Header Channel, Latch Receiver Bracket & Fasteners			Pages 4 to 5 of Guide
 <p>Cable Bikini Top and Windshield Header Channel #423.45</p>	 <p>Latch Receiver Z-Bracket Part #596.45 Qty. 2</p>	 <p>M8 x 1.25 X 80mm Button Head Socket Cap Screw/Washer Part #532.23 Qty. 2</p>	 <p>Bolt Spacer Bezel Part #574.05 Qty. 2</p>	 <p>M8x1.25x38 Button Head Socket Cap Screw/Washer Part #532.17 Qty. 2</p>	
Sections 3 to 6		Fasteners, Straps, Tail Clips			Pages 6 to 9 of Guide
 <p>M8 Nylon Lock Nut #434.12 Qty. 2</p>	 <p>Hook &amp; Loop Snap Straps #589.20 Qty. 2</p>	 <p>Buckle Straps Qty. 2</p>	 <p>Snap Straps Part # 591.20 - 21" Qty. 2 Part # 600.64 - 26" Qty. 2</p>	 <p>Snap Stud Screw #8x5/8" Part #728221 Qty. 4</p>	
			 <p>Tail Clip Part #338.24 Qty. 4</p>		

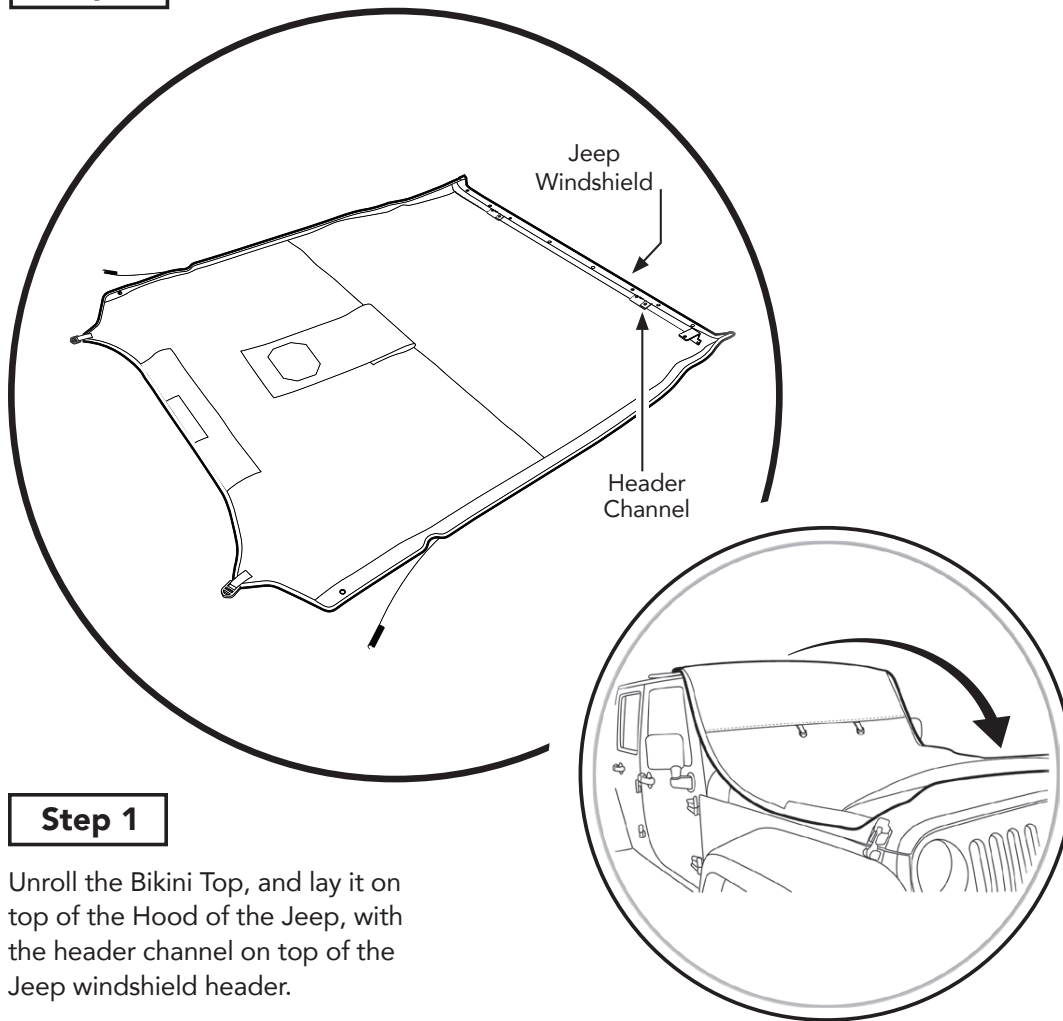
**Step 1****Step 1**

Unroll the Bikini Top, and lay it on top of the Hood of the Jeep, with the header channel on top of the Jeep windshield header.

<b>Step 1</b>	423.45	532.23	596.45	574.05
---------------	--------	--------	--------	--------

**Hardware**

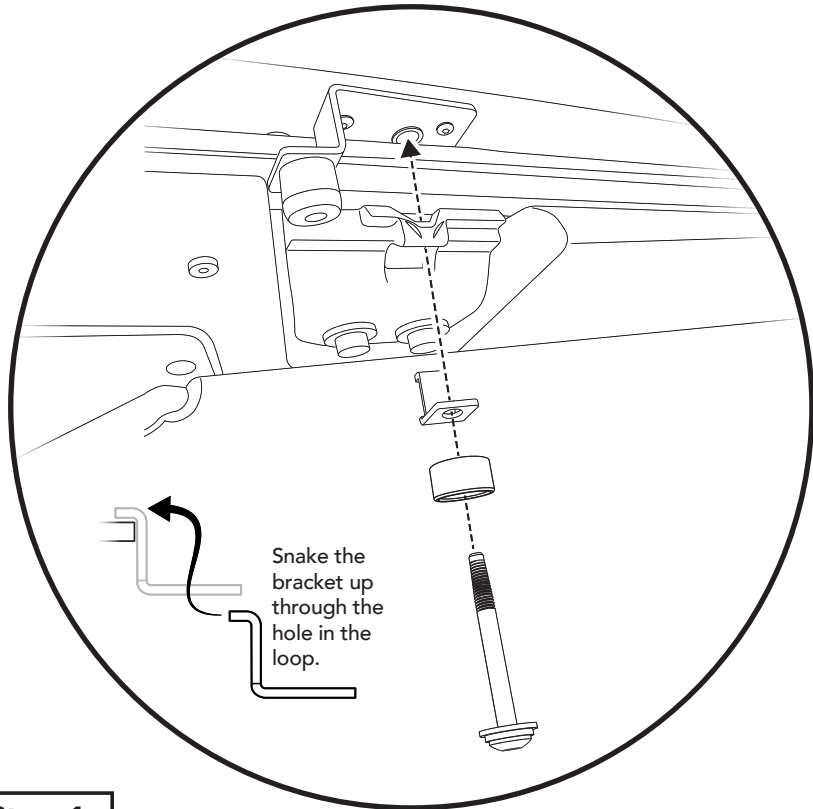

Windshield Header Channel  
Part #423.45  
With Bikini Top attached  
(Bikini not shown)

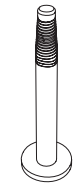

M8 x 1.25 X 80mm  
Button Head  
Socket Cap  
Screw/Washer  
Part #532.23  
Qty. 2

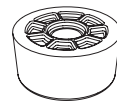

Bolt Spacer Bezel  
Part #574.05  
Qty. 2

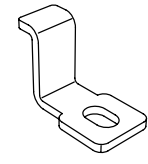

Latch Receiver Z-Bracket  
Part #596.45  
Qty. 2

**Tools**



T40 Torx  
Driver

**Step 1**

Secure the Bikini Windshield Header Channel #423.45 to the Jeep windshield header, using one (1) Latch Receiver Bracket #596.45, one (1) M8x1.25x80mm Button Head Socket Cap Screw/Washer #532.23, and one Bolt Spacer Bezel #574.05 per side.

The Latch Receiver Bracket and the M8x1.25x80mm long Screw/Washer with additional M8 washer and Spacer Bezel are attached from the underside to secure the Latch Receiver Bracket to the windshield header.

The Latch Receiver Bracket must be snaked up through the hole in the windshield header latch loop, so that the lip at the top of the bracket catches the horizontal edge on the header.

Do not tighten this fastener until after installing the Button Head Socket Screw #532.17 in Section 3 Step 1 (on the following page).

**Step 1**

532.17

434.12

**Hardware**

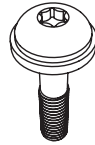

M8x1.25x38  
Button Head  
Socket Cap  
Screw/Washer  
Part #532.17  
Qty. 2



M8 Nylon Lock Nut  
#434.12  
Qty. 2

**Tools**



13mm Wrench



T50 Torx  
Driver

**Step 3**

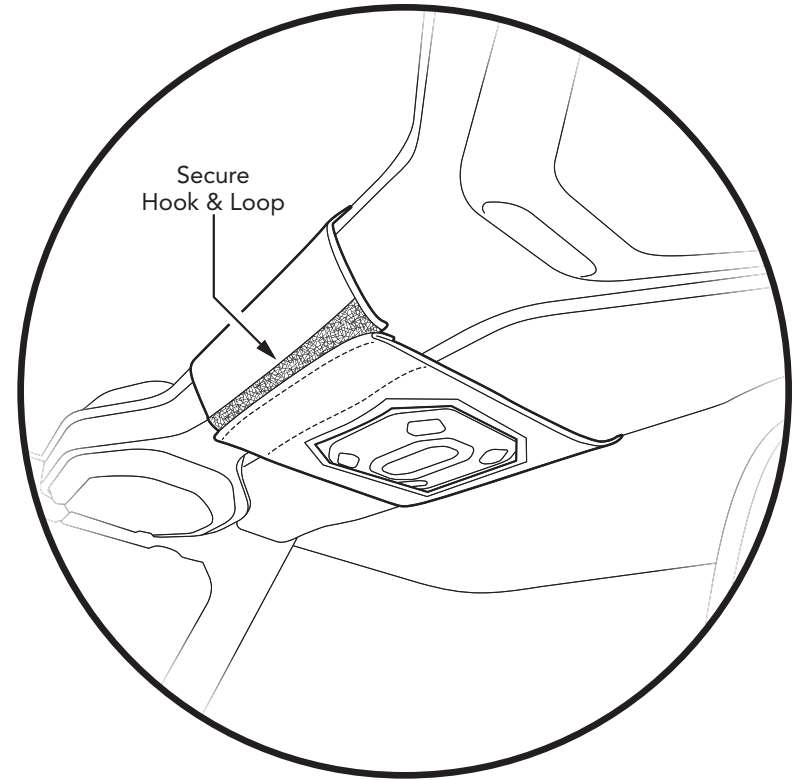
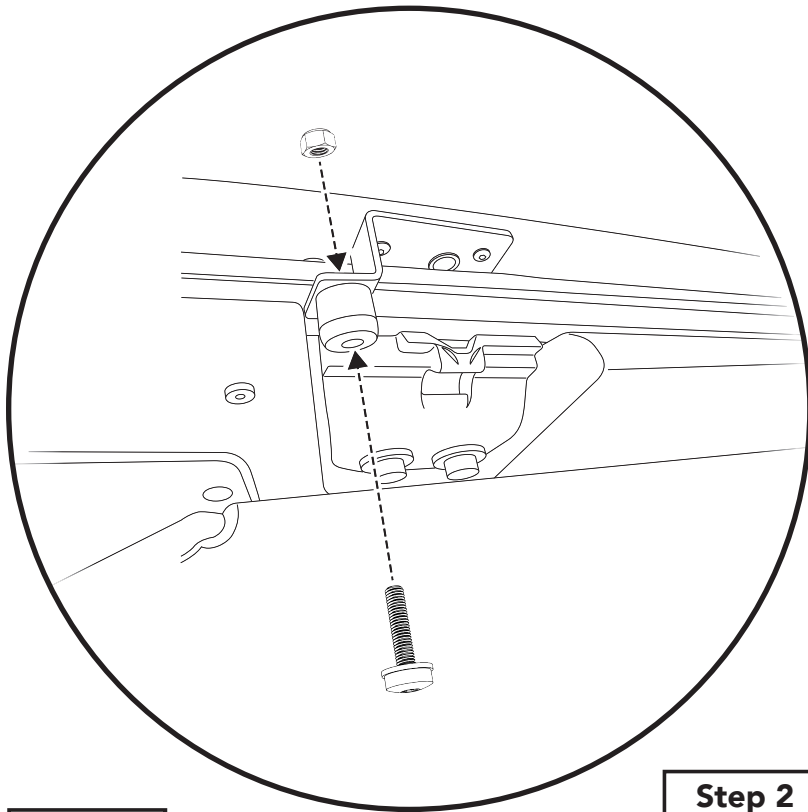

**Step 1**

Attach the M8x1.25x38 Button Head Socket Cap Screws #532.17 from the underside, and secure the pre-attached brackets on the Header Channel to the windshield header, using one (1) M8 Nylon Lock Nut #434.12 on top of each pre-attached bracket.

**Step 2**

Lay the fabric top back across the Jeep, over the soundbar and sportbar.

**Step 2**

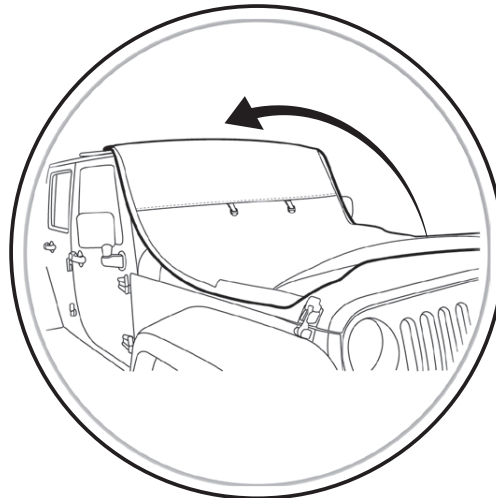

**Step 3**

Wrap the Soundbar Flap around the soundbar, and secure using the PSA Hook & Loop strip.

Make sure that all lights on the underside of the soundbar are exposed.

**Step 1** 589.20

**Hardware**

**Step 2** Buckle Straps

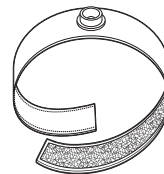
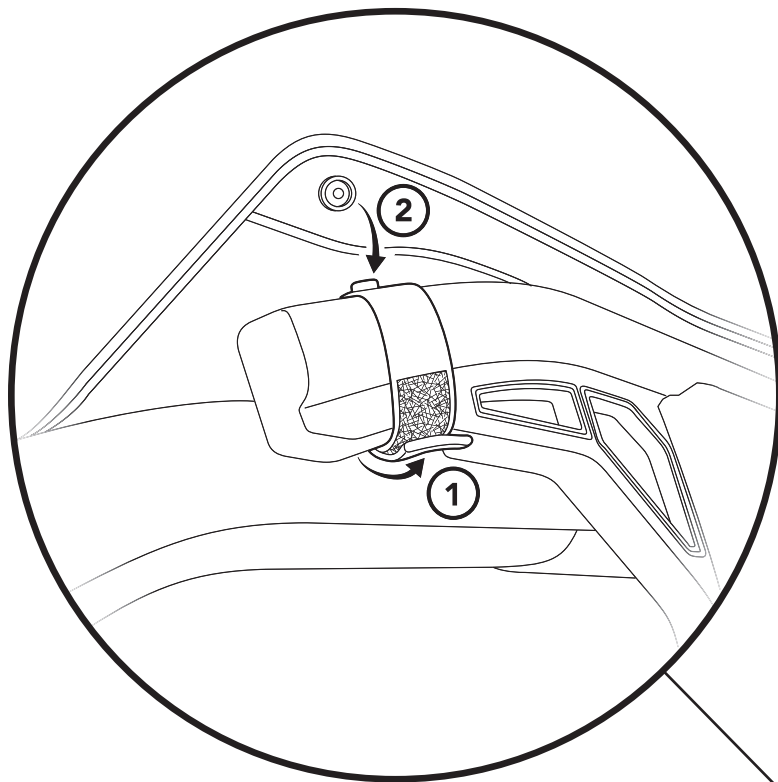

Hook & Loop Snap Straps  
#589.20  
Qty. 2

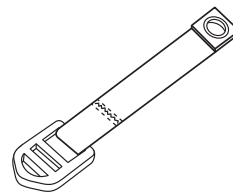

Buckle Straps  
Qty. 2

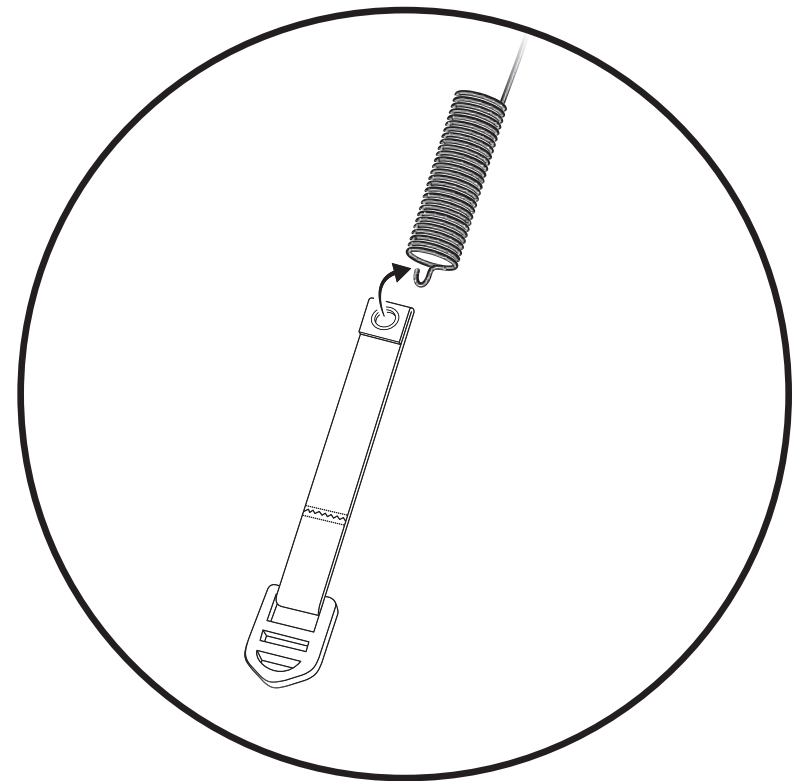

**Step 1**

Tightly wrap a Hook & Loop Snap Strap #589.20 around the rear leg of each rear Door Rail, with the snap on the top of the strap.

Snap each rear corner of the Cable Bikini Top to the Snap Straps.

**NOTE:** The Hook & Loop strip on the underside middle rear of the Bikini Top is for optional equipment.

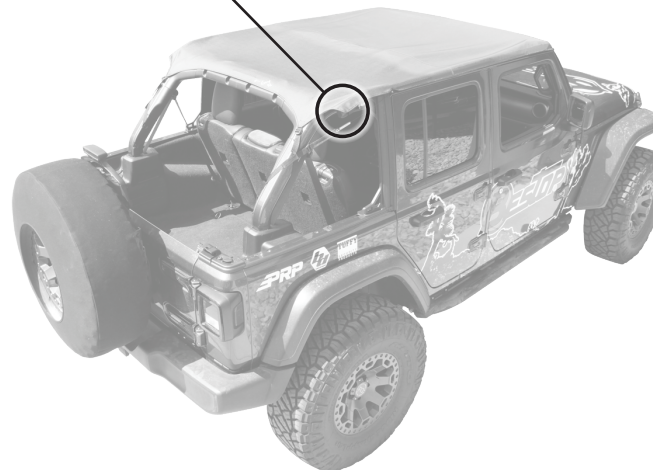

**Step 2**

Locate the spring on the end of each cable, where it exits the fabric top near the middle of the rear sport bar.

Attach the grommet end of each Buckle Strap to the end of the spring.

**Step 1**

**Hardware**

**Step 2** Grommet Straps

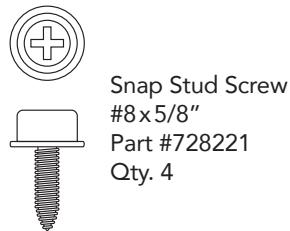
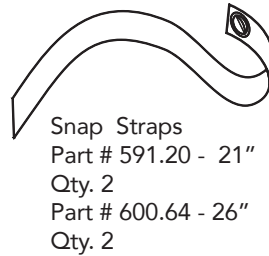
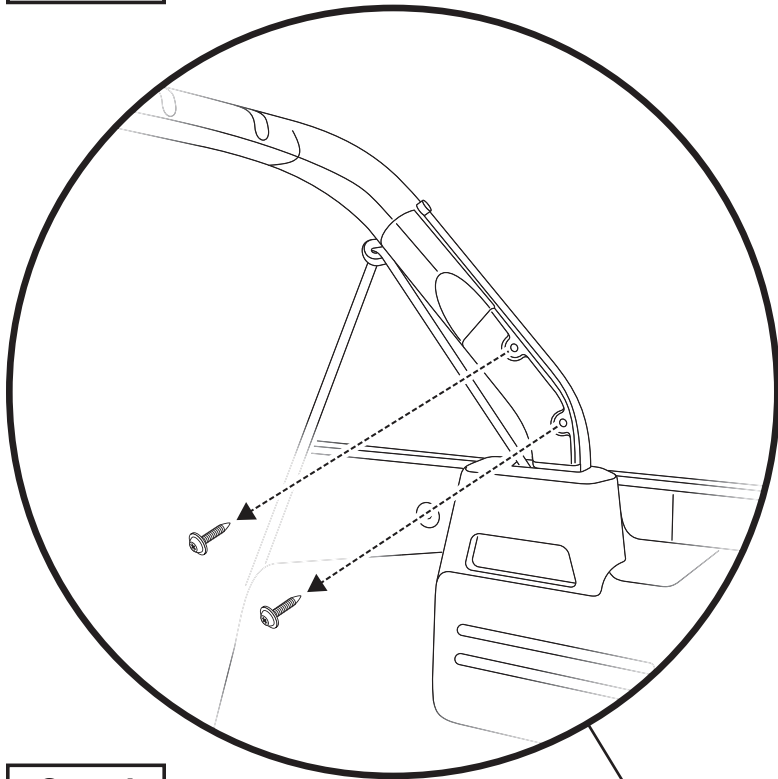

**Tools**



T25 Torx Driver  
Phillips Driver

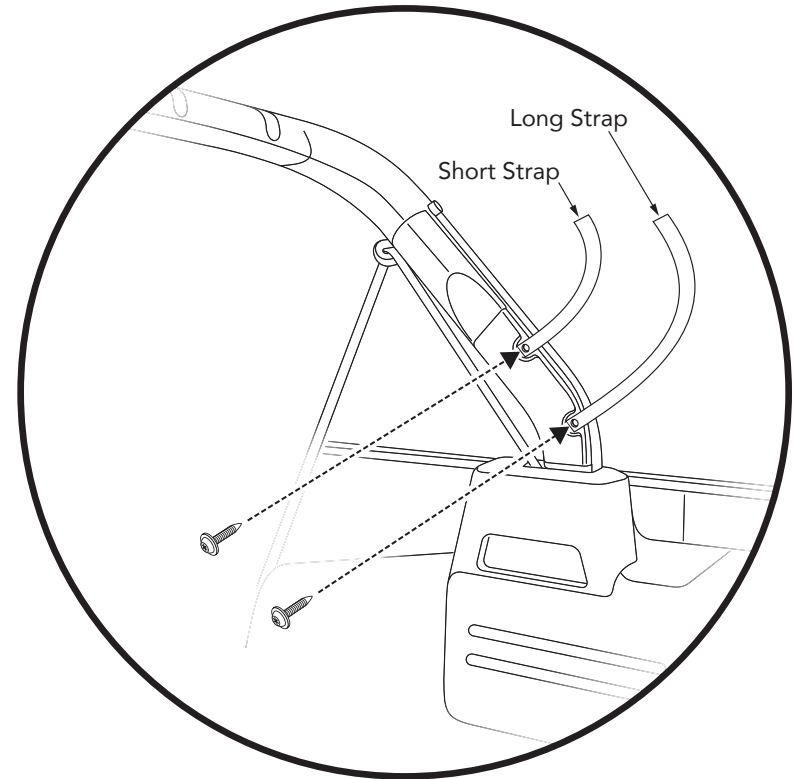

**Step 1**

Remove the two (2) Torx screws on the inside of each sport bar down tube.  
Replace with 728221 Snap Stud Screw

**Step 2**

Using the 728221 Snap Screws, attach the Snap Straps to the sport bar down tubes in the locations where you removed the screws in the previous step.

Attach the Long (26") Straps in the bottom holes, and the Short (21") Straps in the upper holes.

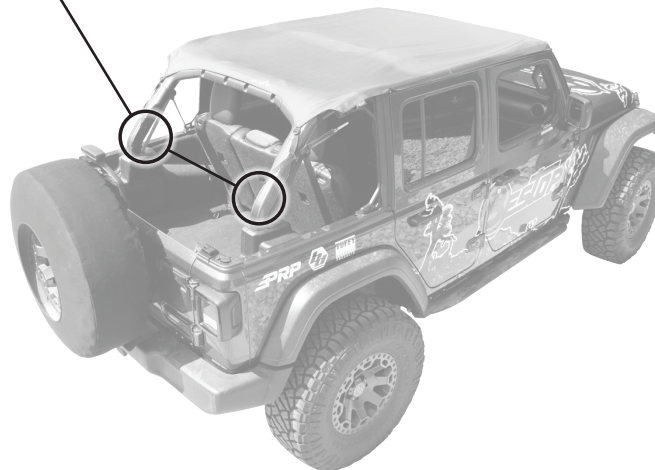



**Step 1**

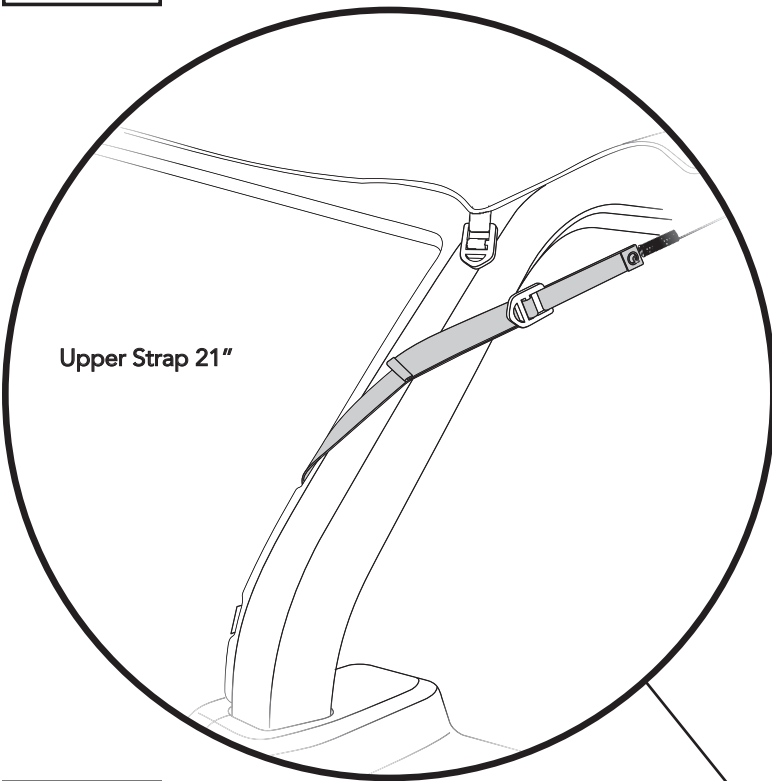

**Hardware**



Tail Clip  
Part #338.24  
Qty. 4

**Step 2**

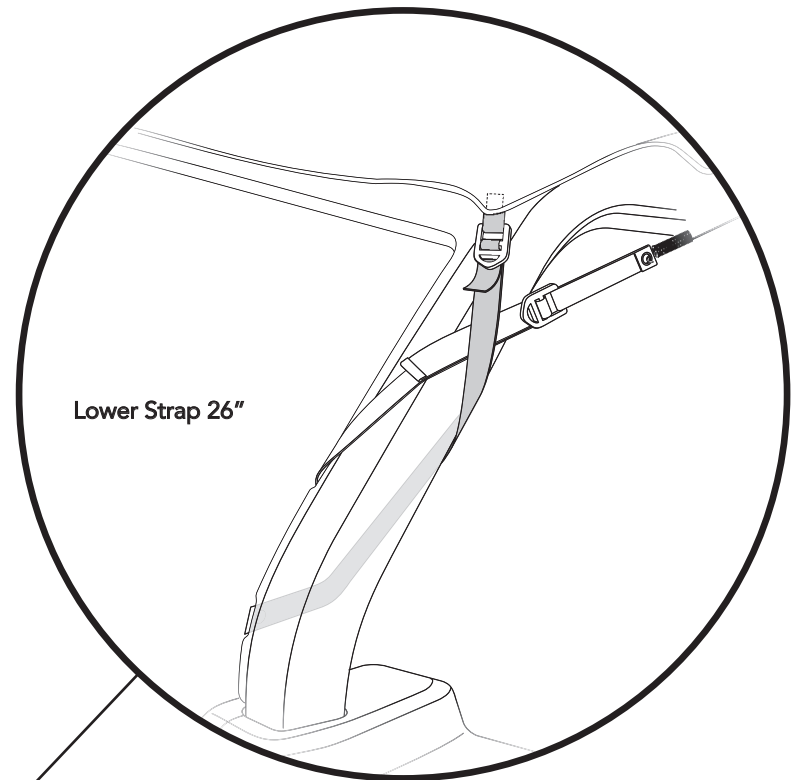

**Step 1**

Wrap the Upper (20" Short) Strap around the Sport Bar.

Wrap the strap over the top of the sport bar and attach the end of the Strap to the buckle at the end of the Spring Cable.

Cinch this strap down tightly.

**NOTE:** The Cable must go below the Shoulder Screw (shown on Page 6, section 2).

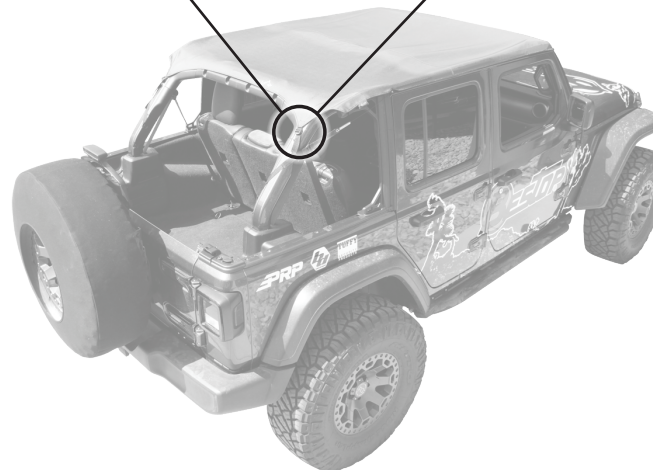

**Step 2**

Wrap the lower (26" Long) Strap around the Sport Bar.

Wrap the strap underneath the sport bar and around over the top, and attach the end of the Strap to the buckle at the corner of the Bikini Top. Cinch down tightly.

This Strap will go over the top of the previously installed Strap.

Dress loose strap ends using Tail Clips #338.24.



## Warranty Information Cable Bikini Top

Vehicle Application:  
Jeep® Wrangler Unlimited JL 2018-Current  
Part Number 52608

### WHAT BESTOP WARRANTS

Subject to the terms and conditions of sale, including any terms and conditions set forth by Bestop, Inc. (“Bestop” or “us” or “we”) in our then-current terms of sale on our website (collectively, the “Terms”), Bestop represents and warrants that: the covered products listed in the “Covered Products and Warranty Periods” section (a “Product”) will substantially be free from defects in materials and workmanship for the specified warranty periods set forth in that section.

### THE WARRANTY IS LIMITED AND CONDITIONAL

This warranty applies to the original purchaser of the Product only. The warranty is valid only as long as the original retail purchaser owns the vehicle upon which the Product is installed. The warranty expires should the Product be removed from the original vehicle or if the original vehicle is transferred to another owner.

This warranty is not transferable or assignable. The warranty does not apply to Product bought from auction-style or price-bid websites.

THE LIMITED WARRANTY AND STATED REMEDIES ARE SOLE AND EXCLUSIVE AND IN LIEU OF ALL OTHER WARRANTIES AND REMEDIES, AND COMPANY EXPRESSLY DISCLAIMS ALL IMPLIED OR STATUTORY OR OTHER WARRANTIES, INCLUDING WITHOUT LIMITATIONS WARRANTIES OF MERCHANTABILITY, NON-INFRINGEMENT OR FITNESS FOR A PARTICULAR PURPOSE. IN NO EVENT WILL COMPANY BE LIABLE FOR ANY SPECIAL, INCIDENTAL, CONSEQUENTIAL, PUNITIVE, INDIRECT OR EXEMPLARY DAMAGES OF ANY KIND, INCLUDING LOST PROFITS OR REVENUE, HOWEVER CAUSED, WHETHER FOR BREACH OR REPUDIATION OF CONTRACT, TORT, BREACH OF WARRANTY, NEGLIGENCE, OR OTHERWISE, WHETHER OR NOT COMPANY WAS ADVISED OF THE POSSIBILITY OF SUCH LOSS OR DAMAGES.

*Some states do not allow exclusion or limitation, so this may not apply to you. This warranty gives you specific legal rights, and you may have other rights which vary from state to state.*

### EXCLUSIONS TO THE WARRANTY

The Limited Warranty excludes, and Bestop is not liable in any way for any warranty claims, damages, or defects related to:

- Misuse, abuse, accidents, vandalism, negligence, fire, or improper installation or modification, or improper or inadequate maintenance;
- Failure to comply with any Product documentation, Bestop instructions, or applicable law or regulations; use in extreme conditions
- Force Majeure including but not limited to, earthquake, hurricane, tornado, flooding, or other disasters natural or man-made, civil unrest, strikes, declared or undeclared war, or lack of performance by, or discontinued product of, supply chain partners whose products, software, operations or management is beyond the control of Bestop;
- Damage resulting in breakage (including without limitation, spontaneous breakage, accidental breakage or breakage by any other means) of a Product or any component part;
- Damage to vinyl windows due to misuse, or cracking due to varying weather conditions.

### YOUR SOLE REMEDY

During the applicable warranty period, Bestop shall, at its option, either repair or replace any Product that it confirms, in its discretion, is non-compliant with the warranties herein. Bestop will not pay for labor charges associated with installation or removal of the Product. Should a specific Product be discontinued, Bestop may, at its option, replace the discontinued Product with a current product or like product.

Please retain your proof of purchase. Original proof of purchase for the Product must accompany any warranty claim. If you have a warranty claim, first you must email Bestop Customer Service at [csbestop@bestop.com](mailto:csbestop@bestop.com) for instructions. All claims must be emailed to [csbestop@bestop.com](mailto:csbestop@bestop.com) within 30 days of discovery of a defective Product, but in no event later than thirty days after the end of the applicable Warranty Period (the “Warranty Notice Period”). Warranty claims made after the Warranty Notice Period are null and void and Bestop shall have no responsibility with respect to such claims.

THIS SECTION SETS FORTH BESTOP’S SOLE OBLIGATION & YOUR SOLE REMEDY WITH RESPECT TO ANY DEFECTS OR OTHER PRODUCT ISSUE. ANY PRODUCTS REPLACED UNDER TERMS OF THIS WARRANTY WILL BE COVERED UNDER TERMS & BALANCE OF THE DURATION OF THE ORIGINAL LIMITED WARRANTY FOR SUCH PRODUCT.



## Warranty Information Cable Bikini Top

Vehicle Application:  
Jeep® Wrangler Unlimited JL 2018-Current  
Part Number 52608

**COVERED PRODUCTS AND WARRANTY PERIODS:** The warranty time periods are as follows for Products manufactured by Bestop:

### **BESTOP® LIMITED LIFETIME WARRANTY**

Trektop® Pro Twill Fabric Top Sunrider® for Hardtop Twill Fabric Top  
Trektop® NX Glide Twill Fabric Top Replace-a-Top™ Twill Fabric Top  
Trektop® NX Twill Fabric Top Supertop® NX Twill Fabric Top  
EZFold™ Soft Tonneaus Floor & Cargo Liners  
ZipRail™ Soft Tonneaus Pet Barriers  
EZRoll™ Soft Tonneaus

### **BESTOP® 5-YEAR LIMITED WARRANTY**

Trektop® NX Glide™ Top (non-Twill) Sunrider® for Hardtop (non-Twill) Replace-a-Top™ Top (non-Twill) Trektop® NX Top (non-Twill)  
Sailcloth Replace-a-Top™ Supertop® NX Top (non-Twill)  
Tigertop™ and Halftop™ Supertop® Classic Soft Top Sunrider® Complete Soft Top Supertop® for Truck  
EZ Fold Hard Tonneau

### **BESTOP® 3-YEAR/100K MILES LIMITED WARRANTY**

Powerboard® & Powerboard® NX  
Trekstep®, Side Mount  
Trekstep®, Rear Mount

### **BESTOP® 3-YEAR LIMITED WARRANTY**

Pavement Ends Sprint Top

### **BESTOP® 2-YEAR LIMITED WARRANTY**

Trektop® Classic Soft Top  
RoughRider™ Soft Storage

### **BESTOP® 1-YEAR LIMITED WARRANTY**

All other Bestop® & Pavement Ends™ products not specified above.

**For further information or request for warranty work, please contact:**

**Bestop Inc. Customer Service**  
**Toll-Free: (800)845-3567**  
**Main: (303)465-1755**  
**E-mail: [csbestop@Bestop.com](mailto:csbestop@Bestop.com)**  
**Website: [www.Bestop.com](http://www.Bestop.com)**