



# FITTING INSTRUCTIONS

Part Number: **5650390 / 5650410**

Product **JEEP JT GLADIATOR REAR BAR**

Description:

Suited to **SPORT, SPORT S, OVERLAND**

vehicle/s: **\*\*RUBICON MODELS (AND OTHER MODELS WITH A STEEL REAR BUMPER) WILL NEED THE FOLLOWING LIGHT BEZEL ITEMS PURCHASED FROM JEEP FOR CORRECT LICENCE PLATE LIGHT FITMENT:**

**6KM22RXFAA, 6KM23RXFAA, 6TB06RXFAA, 6TB07RXFAA**

Optional

Accessory: **5750400 – LOWER PROTECTION RAIL KIT**

## WARNING

### NOTE THE FOLLOWING:

- ◆ This product must be installed exactly as per these instructions using only the hardware supplied.
- ◆ In the event of damage to any component, contact your nearest authorised ARB stockist.
- ◆ Do not use this product for any vehicle make or model, other than those specified by ARB.
- ◆ This product or its fixing must not be modified in any way.
- ◆ The installation of this product may require the use of specialized tools and/or techniques
- ◆ It is recommended that this product is only installed by trained personnel.
- ◆ These instructions are correct as at the publication date. ARB Corporation Ltd. cannot be held responsible for the impact of any changes subsequently made by the vehicle manufacturer.
- ◆ During installation, it is the duty of the installer to check correct operation/clearances of all components.
- ◆ Work safely at all times.
- ◆ Unless otherwise instructed, tighten fasteners to specified torque.

## ARB 4x4 ACCESSORIES

Corporate Head Office

42-44 Garden St  
Kilsyth, Victoria  
AUSTRALIA 3137

Tel: +61 (3) 9761 6622  
Fax: +61 (3) 9761 6807

Australian enquiries  
North & South American enquiries

sales@arb.com.au  
sales@arbusa.com

**www.arb.com.au**

# GENERAL CARE AND MAINTENANCE

By choosing an ARB Bar, you have bought a product that is one of the most sought after 4WD products in the world. Your bar is a properly engineered, reliable, quality accessory that represents excellent value. To keep your bar in original condition it is important to care and maintain it following these recommendations:



- Prior to exposure to the weather your bar should be treated to a Carnauba based polish on all exposed surfaces. It is recommended that this is performed on a six monthly basis or following exposure to salt, mud, sand or other contaminants.
- As part of any Pre Trip Preparation, or on an annual basis, it is recommended that a thorough visual inspection of the bar is carried out, making sure that all bolts and other components are torqued to the correct specification. Also check that all wiring sheaths, connectors, and fittings are free of damage. Replace any components as necessary. This service can be performed by your local authorized ARB Stockist.

## FITTING REQUIREMENTS

### REQUIRED TOOLS FOR FITMENT OF PRODUCT:

BASIC TOOL KIT	METRIC SOCKET SET
METRIC ALLEN KEY SET	METRIC TORX KEY SET
FLAT BASTARD FILE	TORQUE WRENCH

### HAVE AVAILABLE THESE SAFETY ITEMS WHEN FITTING PRODUCT:

Protective eyewear		Hearing protection	
--------------------	---	--------------------	---

**NOTE: 'WARNING' notes in the fitting procedure relate to OHS situations, where to avoid a potentially hazardous situation it is suggested that protective safety gear be worn or a safe work procedure be employed. If these notes and warnings are not heeded, injury may result.**

### FASTENER TORQUE SETTINGS:

SIZE	Torque Nm	Torque lbft
M6	9Nm	7lbft
M8	22Nm	16lbft
M10	44Nm	32lbft
M12	77Nm	57lbft
M14	120Nm	88lbft

## PARTS LISTING

APPLICATION.	PART NO.	QTY	DESCRIPTION
BAR FITMENT	180302	8	CABLE TIE
	2125484	2	RECOVERY POINT WARNING LABEL
	3163091	1	BLANKING PLUG 17.4mm
	3163222	2	BLANKING PLUG PARKING SENSOR
	3191338	1	TREADPLATE
	3540290	1	SENSOR SURROUND KIT
	4581018	8	WASHER FLAT M14x23.5x5 TZP480
	4584363	4	WASHER FLAT M12x26x4 TZP480
	4654740	1	REAR BAR
	4654743	2	RECOVERY POINT
	6151062	4	NUT HEX M14x1.5
	6151258	4	BOLT HXHD M14x1.5x80
	6151300	8	NUT CAGED M6
	6151355	4	BOLT HXHD M12x1.75x30 TZP480
	6151384	4	SCREW PAN HEAD BTZP480
	6151657	4	NUT FLANGE M12x1.75 TZP480
	6151975	8	SCREW BUTTON HEAD M6x12 SS
	6821166	2	RED REFLECTOR
	6821189	4	GROMMET ROUND
	211512	1	OPERATOR INSTRUCTION CARD
OPTIONAL: FOG LIGHT FITMENT	PART NO.	QTY	DESCRIPTION
	6821189	6	GROMMET ROUND
	6151384	6	SCREW PAN HEAD BTZP480
OPTIONAL: LOWER PROTECTION RAIL KIT	PART NO.	QTY	DESCRIPTION
	215637	2	DECAL ARB
	4581303	4	WASHER FLAT M8x25.4x3 ZNB480
	4584361	4	WASHER FLAT M10x25x4 TZP480
	6151232	4	BOLT HXHD M10x1.5x30 TZP480
	6151235	4	NUT FLANGE M6x1.25 BZP
	6151234	4	BOLT HXHD M8x1.25x25 BTZP480
	6500002	2	TUBE BLANKING PLUG RUBBER 60.3mm
	6562796R	1	PROTECTION RAIL RH
	6562796L	1	PROTECTION RAIL LH

## FITTING PROCEDURE

### Removal of OE bumper



1. If vehicle comes with factory side protection rails, these must be removed prior to bumper removal.
2. Remove the 5x bolts securing each side protection rail on. There are 3 bolts connecting them to the chassis and 2 connecting them to the rear bumper.
3. Remove side protection rails and discard.



4. Disconnect the wiring harness on each side of the chassis. Also undo the clip that holds the harness to the chassis.
5. Unplug the rear of the trailer smart connector.



6. Remove number plate and then remove the 2x bolts in the centre of the bumper and discard.

## FITTING PROCEDURE



7. Remove the 2x torx head bolts holding the bottom edge of the bumper and discard.



8. Remove the 2x nuts on each side that hold the OE bumper to the chassis and discard.



9. OE bumper can now be removed. With the aid of another person, carefully lift off bumper ensuring the vehicle body does not get scratched.
10. Set bumper aside for removal of sensors, lights and harness.



11. Remove 2x bolts on each OE tow hook. Remove tow hooks and discard.
12. Vehicle should now look like below image:



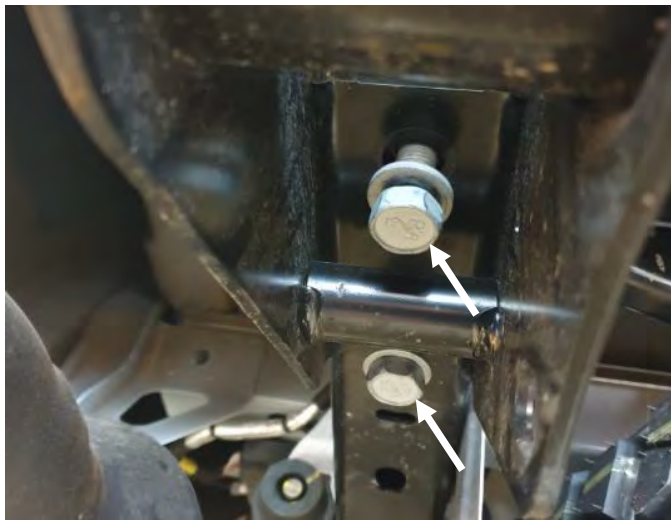

### Fitment of ARB Recovery Points

- Remove the 4x M14 bolts on the underside of the OE towbar. (2 on each side). Retain bolts for use on ARB recovery points. Leave the side bolts in place as shown below:



- Slide in recovery point as shown. Orientation must be as shown in Left image with the 10mm welded packer facing upwards.



- Loosely affix each recovery point using 2x M14x80 bolts, 4x M14 flat washers, 2x M14 nuts.
- Loosely reinstall the 4x bolts removed in step 13 through the rear of the recovery points and into the chassis. (2 per side).
- Tighten all 4 bolts per recovery point to the specified torque.

 M14 – 120Nm



### ARB Bar Preparation



- Set the OE bumper bar and ARB bar upside down on a soft surface in the same orientation as each other.



19. The ARB sensor housings are installed from the front of the bar, with the backing clip securing it from behind.

**Parking sensor relocation: (For models without parking sensors continue from step 30)**

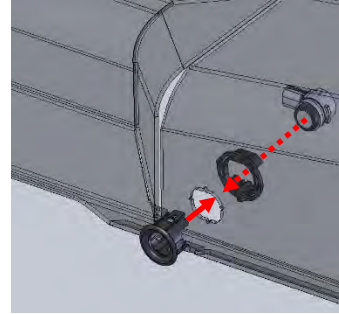

20. Unplug the 4x sensors in the OE bumper bar

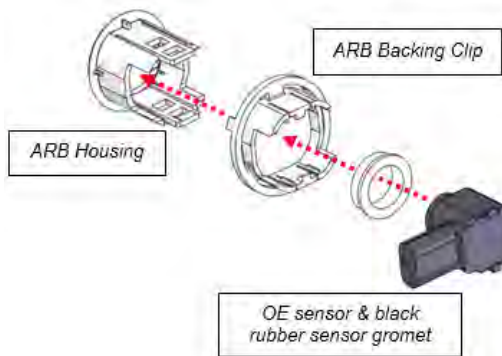

**Generic Image Only**

21. Carefully remove each sensor and install one at a time into the correct position in the ARB bar.
22. Carefully clip each sensor into the housings from behind after the backing clip has been installed.
23. **Note:** Ensure that the black rubber gromets are still seated on the sensors.



24. The sensors should be installed as shown.



25. Unplug the OE bumper wiring loom from the licence plate lights (and fog lights if installed).
26. Unclip the loom from the bumper by carefully pulling on the clips.
27. The loom should now be free to move across to the ARB bar



28. Move the loom to the ARB bar, ensuring its orientation remains the same as in the OE bar.
29. Plug the loom into the 4x parking sensors.
30. **Non-Sensor models;** Locate and install the 4x Sensor Hole Blanking Plugs provided in the fitting kit.



31. Unclip the OE licence plate light assemblies and remove.
32. The backing components will need to be modified to fit into the ARB bar.
33. Using a flat bastard file, remove all raised areas as shown in the lower left image. Housing backings should now look like the image below:



34. Install the licence plate light assemblies into the ARB bar, ensuring they are on the same side and orientation as in the OE bumper.
35. Plug the lights into the loom as shown.



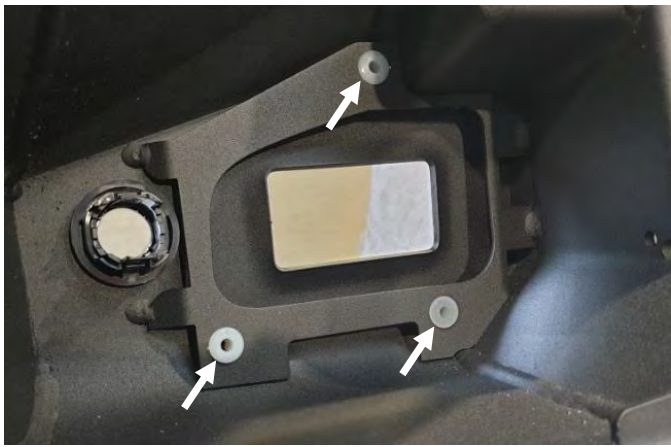

**For models with rear fog lights: Continue with step 36, otherwise continue to step 43.**

36. Fit 3x plastic gromets into each fog light bracket as shown.



37. Remove the fog lights from the OE bumper bar.



38. Using pliers, snap off the 2x location posts on both fog lights.



39. Remove the end moulding on the 2X outer sensor plugs as shown.

**Note: This is only necessary for models with rear fog lights**





40. Install outer parking sensors with the tail facing outwards.
41. Install the fog lights using 3x black pan head screws each side.
42. Plug in the fog lights.

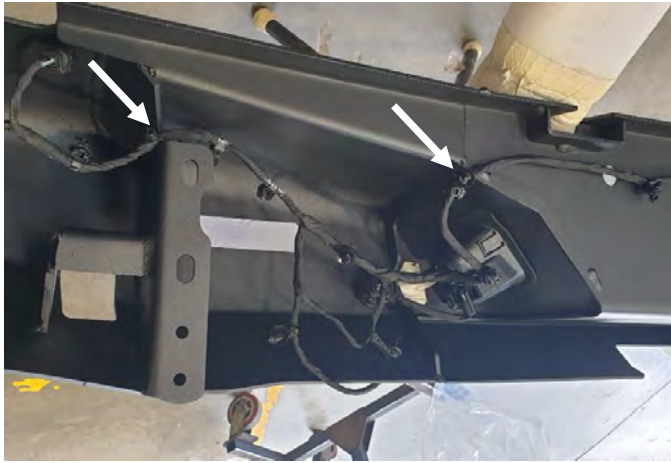

43. Using cable ties, secure the loom as shown. Ensure the loom is not pulled tight anywhere.



44. Remove smart trailer plug from OE Bumper by compressing the clips on the rear. (US models only).



45. Flip the ARB bar over to work on the other side.
46. Fit 8x cage nuts to the underside of the bar, 4x plastic number plate gromets, and the Air chuck blanking plug as shown.





47. Install the aluminium treadplate using 8x M6 stainless steel button head screws as shown.



48. Install the smart trailer plug as shown. Ensure the retaining clips on the underside have opened up and are retaining the plug in the ARB bar.



49. Install the number plate using 4x pan head screws.



### ARB Rear Bar installation

50. With the aid of another person, carefully lift the bar onto the vehicle and slide it over the recovery points.



51. From the inside, affix the bar to the vehicle tow bar using 4x M10 bolts, 4x flat washers and 4x flange nuts as shown. Adjust the bar so the recovery points are central to the cut-outs in the bar:



52. Tighten to specified torque.

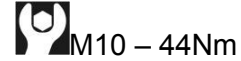

53. Reconnect the wiring harness on both sides of the chassis.  
54. Reconnect the smart trailer plug.

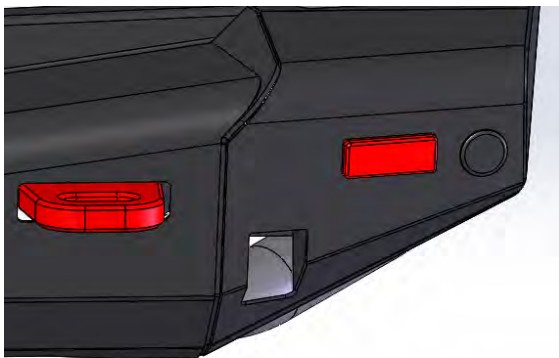

55. Attach tow point rating labels on each side of the vehicle near the tow points in a prominent position.



56. Attach red reflectors on the outer wings as shown.

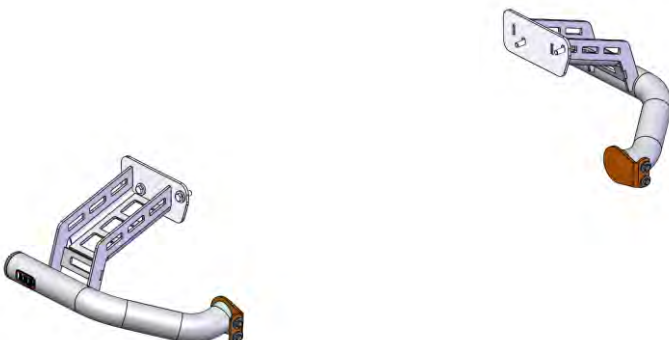

**Optional: 5750400 Lower Protection Rail Kit Install**

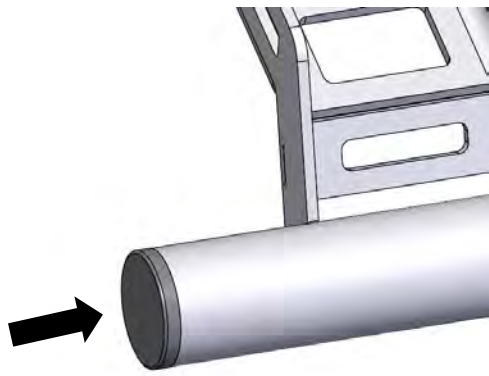

57. Fit the 60.3mm rubber blanking plugs to each protection rail end.

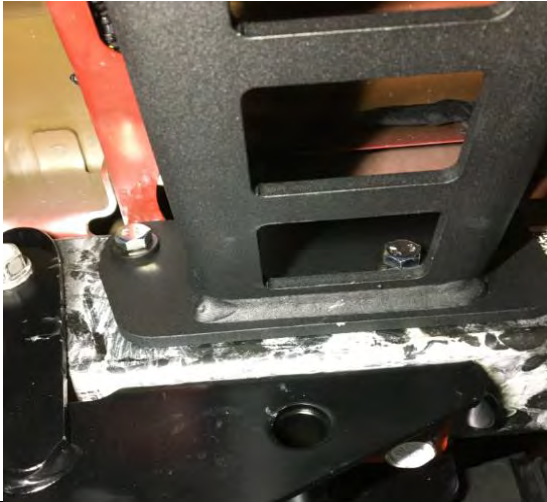

58. Bolt the Lower protection rails to the vehicle chassis using 2x M10x30mm bolts & 2x flat washers per side as shown. Leave finger tight.



59. Bolt the lower protection rails to the rear bar using 2x M8 bolts, 2x flat washers & 2x M8 flange nuts per side as shown. Leave finger tight.



60. Adjust the lower protection rails so they sit parallel to both the vehicle body and the rear bar. Tighten all hardware to specified torque.

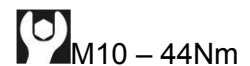
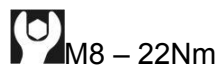

FITTED PRODUCT – 5650390 (US MODEL)



FITTED PRODUCT – 5650410 (AU MODEL)



## FITTED PRODUCT

### **NOTICE: ONCE BAR IS FITTED:**

- ◆ **Ensure all bolts are tensioned correctly.**
- ◆ **All wiring is clear of sharp edges or moving surfaces and secured properly.**
- ◆ **Piping is secured well away from sharp or moving components.**
- ◆ **Check all wiring and connections to lamps and sensors.**
- ◆ **If fitted, test operation of parking sensors after fitment.**

### **NOTE:**

**Sensors may not function well under the following conditions:**

- ◆ **After the vehicle has been sitting out in hot or cold weather.**
- ◆ **When the system is affected by electrical equipment or devices generating an ultrasonic wave.**
- ◆ **When operating in bad weather**