



Nissan 2017-20 Titan 6” Suspension Kit

Thank you for choosing Rough Country for all your suspension needs.

Rough Country recommends a certified technician install this system. In addition to these instructions, professional knowledge of disassemble/reassembly procedures as well as post installation checks must be known. Attempts to install this system without this knowledge and expertise may jeopardize the integrity and/or operating safety of the vehicle.

Please read instructions before beginning installation. Check the kit hardware against the kit contents on the next page. Be sure you have all needed parts and know where they go. Also please review tools needed list and make sure you have needed tools.

PRODUCT USE INFORMATION

⚠ WARNING As a general rule, the taller a vehicle is, the easier it will roll. We strongly recommend, because of rollover possibility, that seat belts and shoulder harnesses should be worn at all times. Avoid situations where a side roll-over may occur.

Generally, braking performance and capability are decreased when larger/heavier tires and wheels are used. Take this into consideration while driving. Do not add, alter, or fabricate any factory or after-market parts to increase vehicle height over the intended height of the Rough Country product purchased. Mixing component brands is not recommended.

Rough Country makes no claims regarding lifting devices and excludes any and all implied claims. We will not be responsible for any product that is altered. We will be happy to answer any questions concerning the design, function, and correct use of our products by calling our toll free number @ 1-800-222-7023.

⚠ WARNING Prior to installation, carefully inspect the vehicle's steering and driveline systems paying close attention to the tie rod ends, ball joints, and wheel bearing preload. Additionally check the steering to frame and suspension to frame attaching points for stress cracks. The overall vehicle must be in excellent working condition. Repair or replace all worn or damaged parts.

This kit is packaged as a leveling kit—raising the front 6” and the rear 4”.

Due to differences in manufacturing, dimension and inflated measurements, tire and wheel combinations should be test fit prior to installation. For this application we recommend a 17” or larger wheel not to exceed 8” in width with a minimum backspacing of 4.5” to a maximum of 5”, a 9” wide wheel with 5” of backspacing is acceptable. Additionally a quality tire of radial design is recommended, not exceeding 35” tall and 12.5” wide is recommended. Please note that use of a 35” x 12.5” tire may require modification to the front valance.

NOTICE TO DEALER AND VEHICLE OWNER

Install the supplied “Warning to Driver” decal installed on the inside of the windshield or on the vehicle’s dash. The decal should act as a constant reminder for whoever is operating the vehicle of its unique handling characteristics.

We hope installing your Rough Country lift kit is a positive experience. Please note that variations in construction and assembly in the vehicle manufacturing process will virtually ensure that some parts may seem difficult to install. Additionally, the current trend in manufacturing of vehicles results in a frame that is highly flexible and may shift slightly on disassembly prior to installation. The use of pry bars and tapered punches for alignment is considered normal and usually does not indicate a faulty product. However, if you are uncertain about some aspect of the installation process, please feel free to call our tech support department at 800-222-7023. We do not recommend that you modify the Rough Country parts in any way as this will void any warranty expressed or implied.



KIT CONTENTS

Please confirm that you have all the needed parts and know where they go prior to beginning installation.

1878Box4

Front Cross Member
Rear Cross Member

1875Box2

Dr Knuckle
Pass Knuckle

1878Box7

Sway Bar Spacer (2)
878INSTBAG1
Driver Side Bump Stop Spacer
Pass Side Bump Stop Spacer
Front Sway Bar Links (2)
1878BAG2
1878BAG6
1875BAG5
Driver Lower Strut Bracket
Pass Lower Strut Bracket
10MMSTUDBAG-1
Front Strut Spacer (2)
Front Bumper Shims (4)
Pass Bumper Bracket (1)

1878Box3

Rear E Brake Line Bracket
Rear Brake Line Bracket
Rear Sway Bar Links (2)
1875BAG5
Rear Block (2)
1878BAG3
6107BAG
1263BAG2
658761 Rear Shock Absorber (2)
9/16" x 2.5" x 12" U-Bolt (4)

1875Box6

Skid Plate

Hardware Bags

1878BAG10—Inst. Sheet Bag

Instruction Sheet
Warning to Driver Decal
Shock Decal (2)

1878BAG6

For Rear Brake Line Brkt
5/16" x 1.25" Bolt (2)
5/16" Nylon Lock Nut (2)
5/16" Washer (4)
8mm x 25mm Bolt (2)
8mm Washer (2)
For Rear E Brake Brkt
5/16" x .75" Bolt (2)
5/16" Nylon Lock Nut (2)
5/16" Washer (4)

1878BAG3

For Rear Brake Line Brkt
5/16" x 1.25" Bolt (2)
5/16" Nylon Lock Nut (2)
5/16" Washer (4)
8mm x 25mm Bolt (2)
8mm Washer (2)
For Rear E Brake Brkt
5/16" x .75" Bolt (2)
5/16" Nylon Lock Nut (2)
5/16" Washer (4)

1878BAG6

For Front Cross Member
9/16" x 4.5" Bolt (2)
9/16" Nylon Lock Nuts (2)
9/16" Washers (4)
For Front Cross Member—Ctrl Arm Mt
Cam Bolt (2)
Cam Nut (2)
Cam Washer (4)
For Rear Cross Member
9/16" x 4.5" Bolt (2)
9/16" Nylon Lock Nuts (3)
9/16" Washers (6)
For Rear Cross Member—Ctrl Arm Mt
Cam Bolt (2)
Cam Nut (2)
Cam Washer (4)
For Front Skid Plate
3/8" x 1" Bolt (4)
For Differential Vent Hose
Differential Vent Hose Ext
Hose Coupler
For Front Brake Line Brkts
Front Brake Line Brkt (2)
3/8" x 1" Bolt (2)
3/8" Nylon Lock Nut (2)
3/8" Washer (4)
For Upr Ball Joint and Tie Rod Ends
Cotter Pin (4)
For Bump Stop Exts.
5/16" x 1" Bolt (2)
5/16" Nylon Lock Nut (2)
5/16" Washer (4)
For Frt Bumper Shims
10mm x 35mm Bolt (6)
10mm Flat Washer (6)

1875BAG5 x 2

For Fr & Rr Sway Bar Links
4-12mm x 65mm Bolts
4-12mm Flange Locknuts
4-12mm Flat Washers
4-12mm Sleeves

9/16 U-Bolt Bag

9/16" Lock Nut (8)
9/16" Washer (8)

Strut Spacer Hardware Bag

10mm Studs (6)
10mm Nuts (6)
10mm Lock Washers (6)

1878BAG2

For Front Strut Bracket
Crush Sleeve (2)
1/2" x 3.5" (2)
1/2" Washer (4)
1/2" Lock Nut (2)
14mm x 80mm (2)
14mm Nylock Nut (2)
14mm Washer (4)

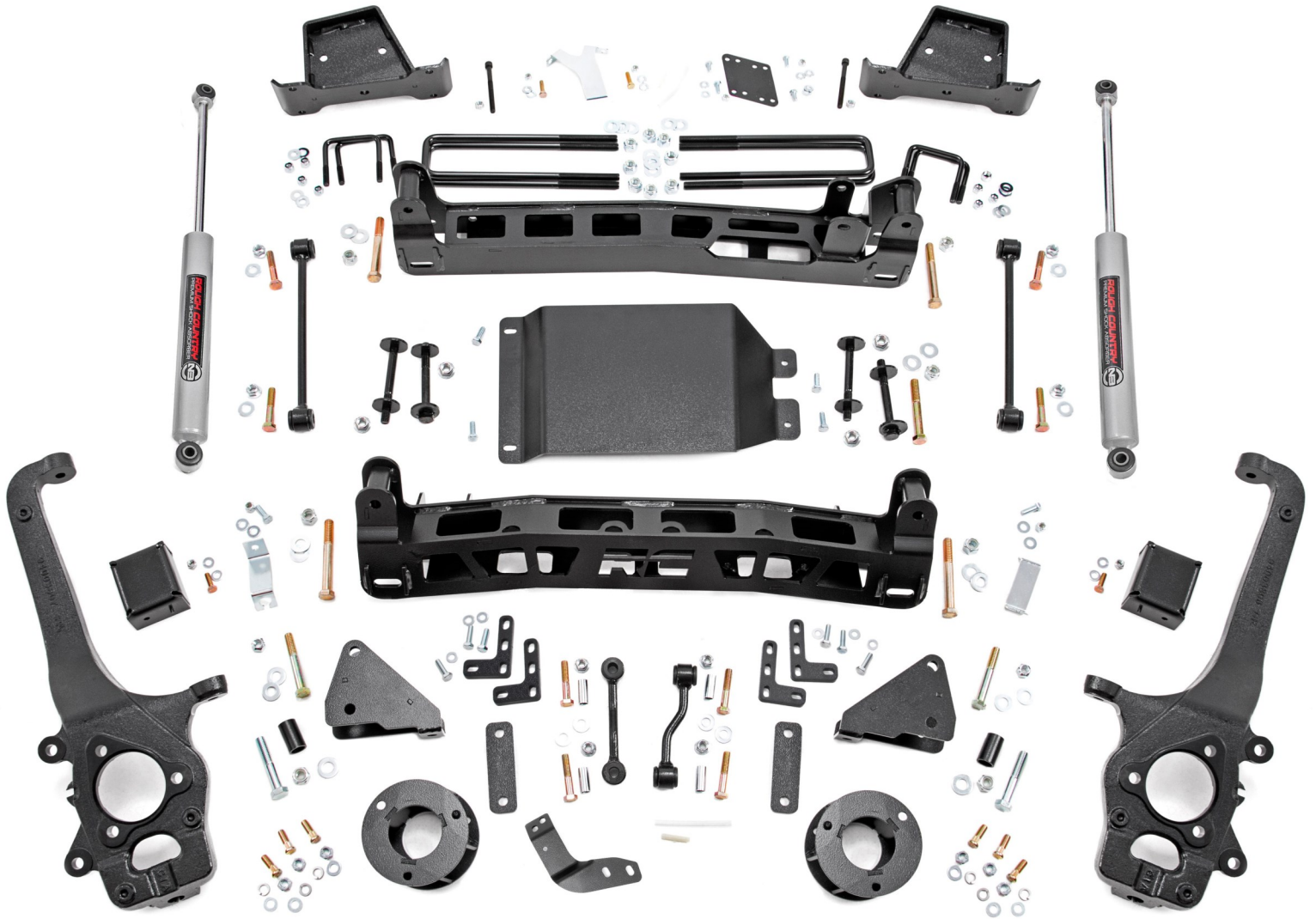

Torque Specs:

Size	Grade 5	Grade 8
5/16"	15 ft/lbs	20 ft/lbs
3/8"	30 ft/lbs	35 ft/lbs
7/16"	45 ft/lbs	60 ft/lbs
1/2"	65 ft/lbs	90 ft/lbs
9/16"	95 ft/lbs	130 ft/lbs
5/8"	135 ft/lbs	175 ft/lbs
	Class 8.8	Class 10.9
8MM	18ft/lbs	23 ft/lbs
12MM	55ft/lbs	75ft/lbs

Tools Needed:

- Floor jack
- Jack stands
- Ratchet
- 13/16" socket
- 5mm Socket
- 10mm Socket
- 12mm Socket
- 14mm Socket
- 15mm Socket
- 17mm Socket
- 19mm Socket
- 21mm Socket
- 22mm Socket
- 30mm Socket
- 32mm Socket
- Pliers
- Hammer

FRONT INSTALLATION INSTRUCTIONS

1. Jack up the front of the vehicle and support the vehicle with jack stands, so that the front wheels are off the ground.
2. Using 21mm socket remove the front tires/wheels.
3. Remove the cotter pin from the tie rod end. **See Photo 1.**
4. Using a 22mm wrench, loosen the tie rod end nut. **Do not remove.** **See Photo 2.**

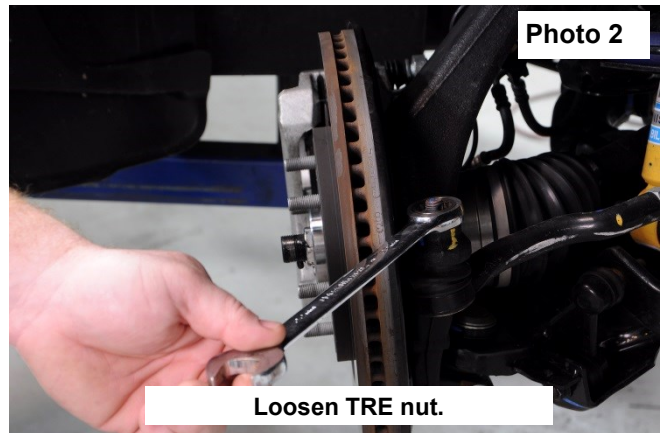
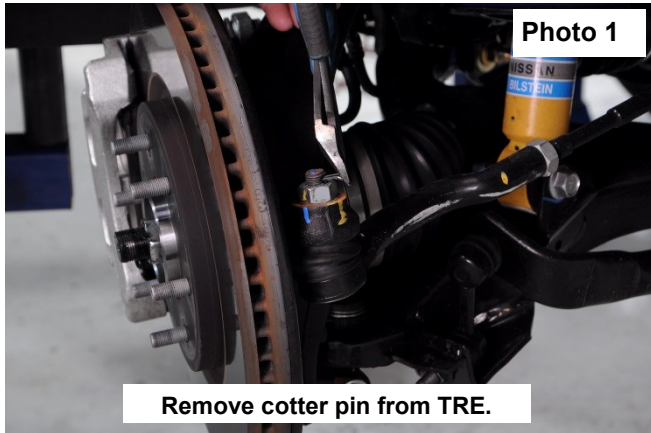

5. Using a hammer, strike the side of the knuckle at the tie rod end to release the taper. Remove nut and move tie rod out of the way. **See Photo 3.**
6. Using a 13mm socket, remove the nut from the brake line bracket. **Photo 4.**

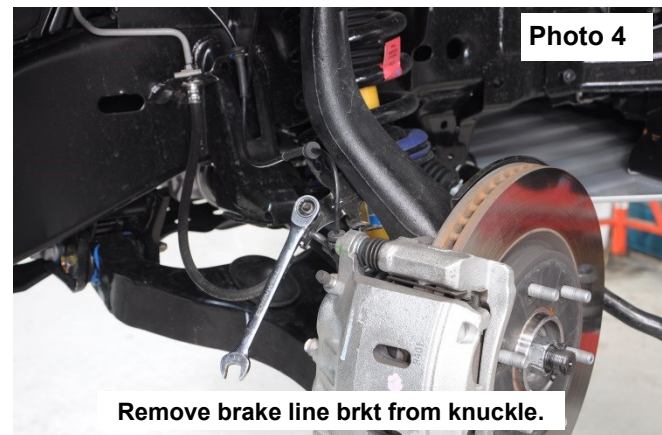

7. Using a 18mm socket, remove the brake caliper bolts and save for reuse. Hang caliper out of the way. ****Do not let calipers hang by the brake line.**** Remove the brake rotor. **See Photo 5.**
8. Using a 5mm Allen, remove the ABS line from the knuckle. **See Photo 6.**

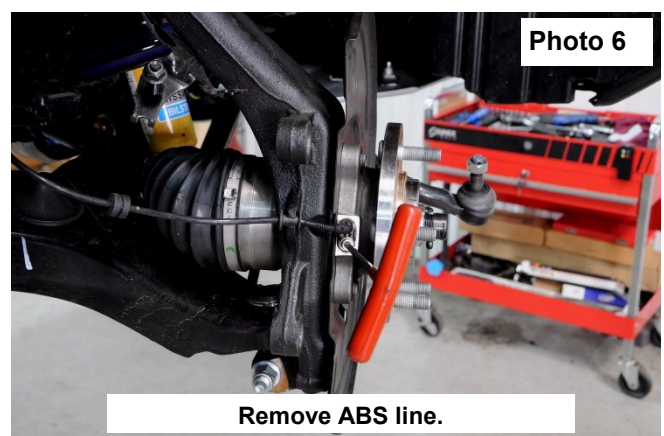
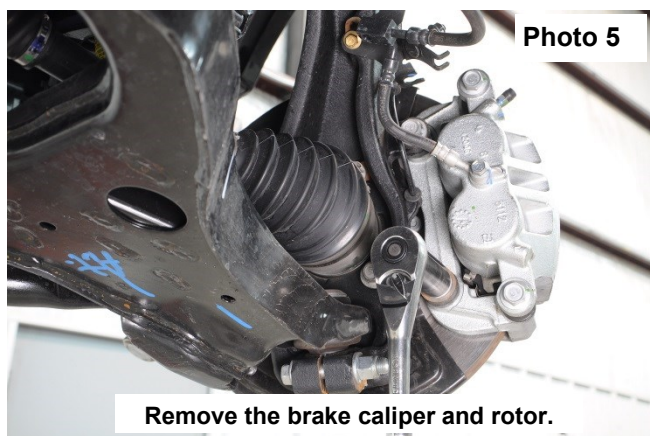

9. Remove the cotter pin from the axle shaft. **See Photo 7.**
10. Using a 34mm socket, remove the axle nut from the axle and save for reuse. **See Photo 8.**

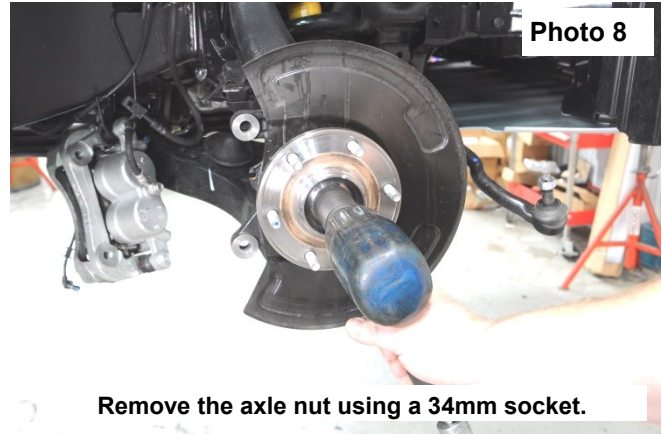

11. Remove the cotter pin from the upper ball joint nut. **Photo 9.**
12. Using a 22mm wrench, loosen the upper ball joint nut. **Do not completely remove. Photo 10.**

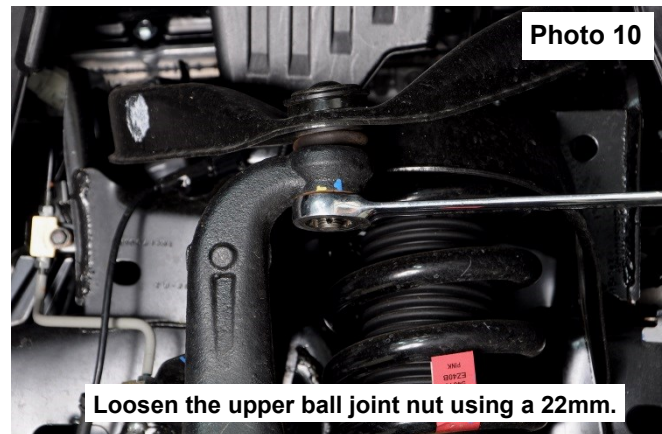
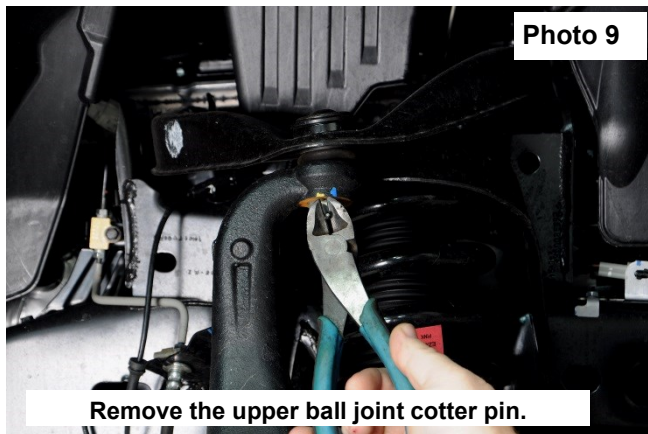

13. Using a hammer, strike the knuckle to release the ball joint taper. Remove the nut and save for reuse. **Photo 11.**
14. Using 17mm and 19mm wrenches, remove the pinch bolt from the lower ball joint, save for reuse, and remove the knuckle, take care not to damage CV. **Photo 12.**

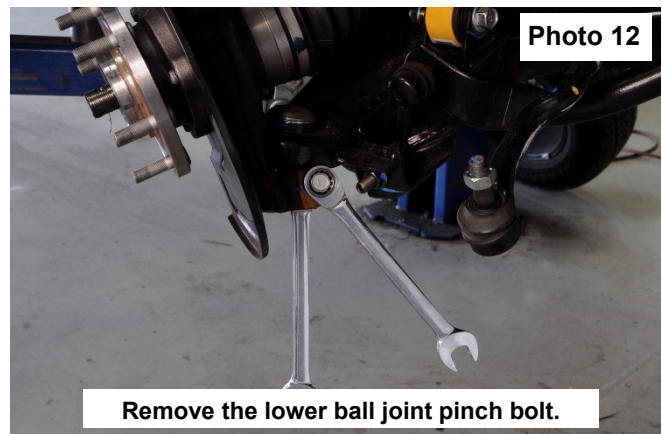

15. Using a 17mm wrench, remove the sway bar link from the lower control arm. **Photo 13.**
16. Using a 19mm socket and wrench, remove the lower strut bolt. **Photo 14.**
17. Using a 14mm socket, remove the upper strut nuts and remove the strut from the truck. **Photo 15.**
18. Using 19mm and 22mm wrenches, remove the lower control arm. **Photo 16.**
19. Using a 12mm socket, remove the 2 plastic skid plates. **See Photo 17.**

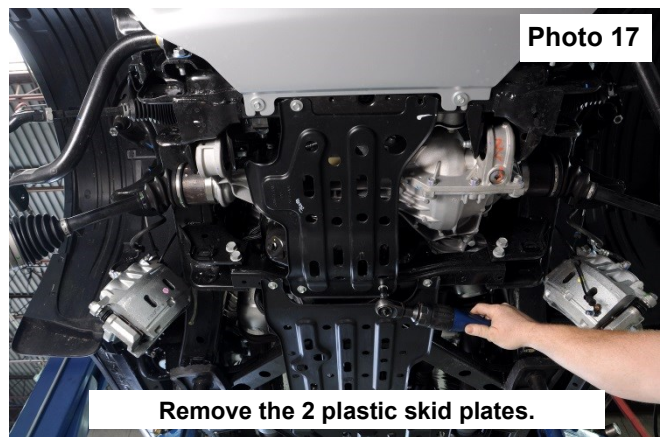
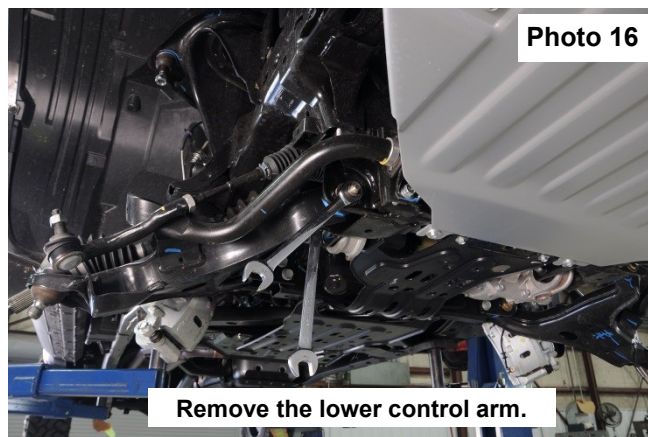
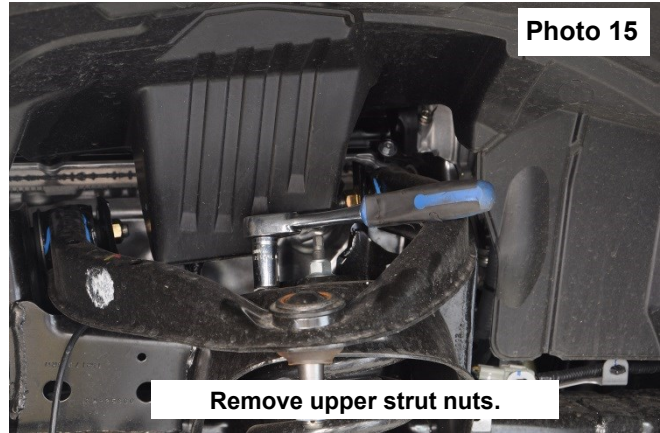
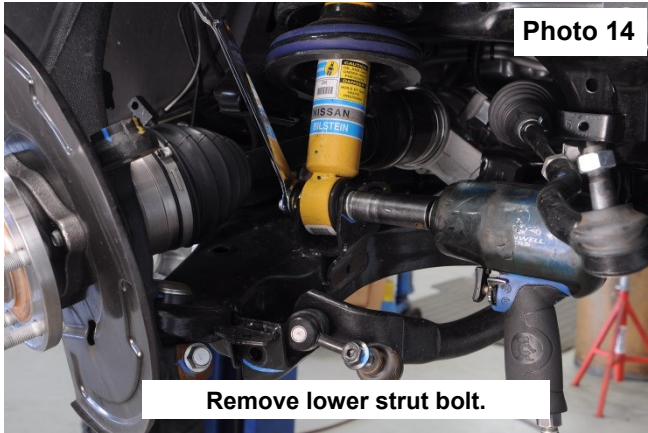

20. Using a 17mm socket, remove the rear cross bracing. **Photo 18.**
21. Using 19mm and 21mm wrenches, remove the rear cross-member. **Photo 19.**

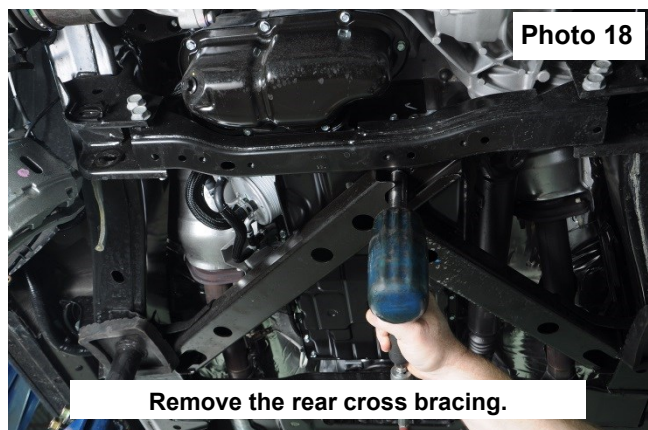

22. Unplug the front diff actuator and remove the clips holding the wire to the diff. Also unplug the vent hose. **Photo 20.**
23. Mark the front driveshaft orientation. **Photo 21.**

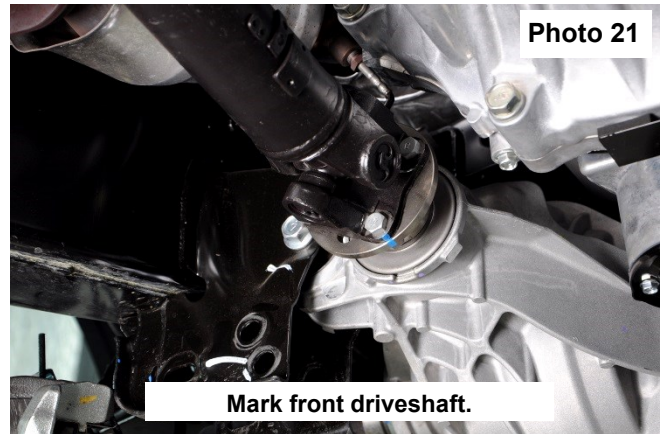
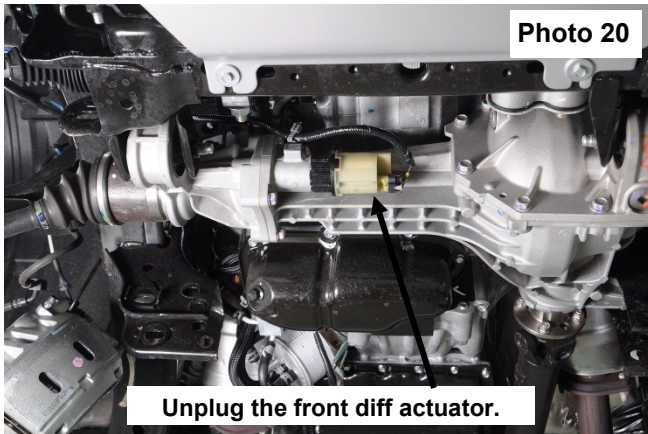

24. Using 14mm wrenches, remove the front driveshaft bolts and save for reuse. **See Photo 22.**
25. Support the front diff and remove the 3 mounting bolts using a 19mm wrench and socket. Save for reuse. **See Photos 23, 24, & 25.**

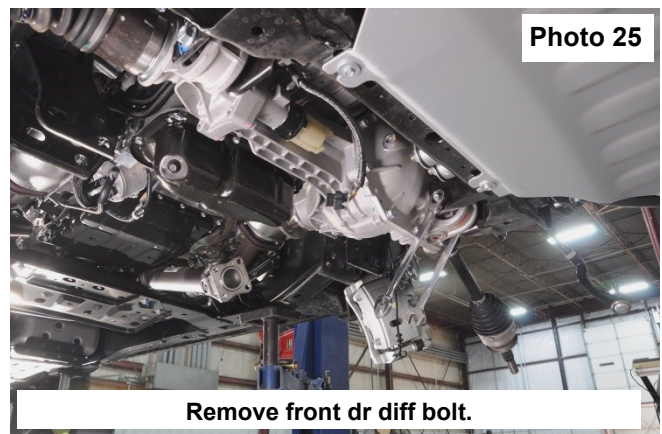
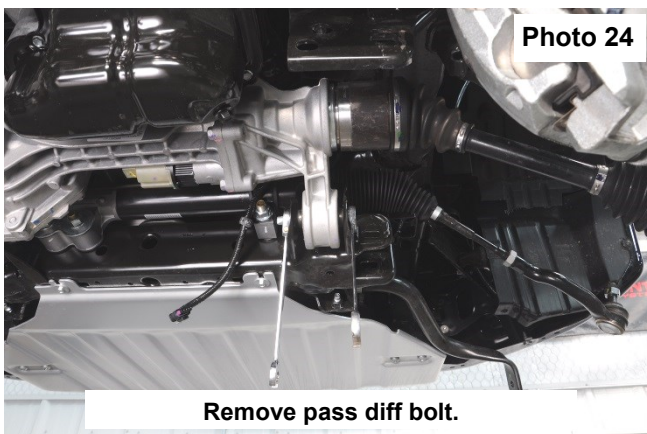
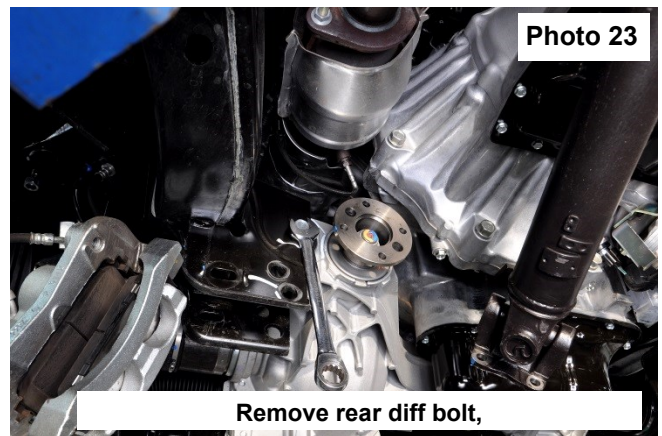
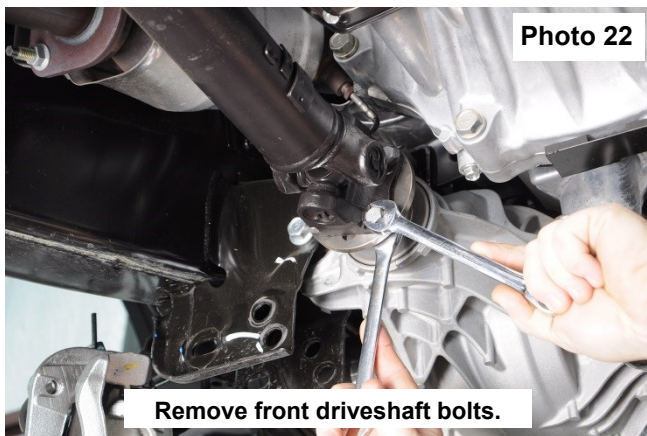

26. Using a grinder, grind the tabs out of the inside of all 4 control arm pockets. Paint to prevent rust. **Photo 26.**
 27. Place the supplied cutting template on the front of the rear driver control arm pocket and mark. **See Photo 27.**

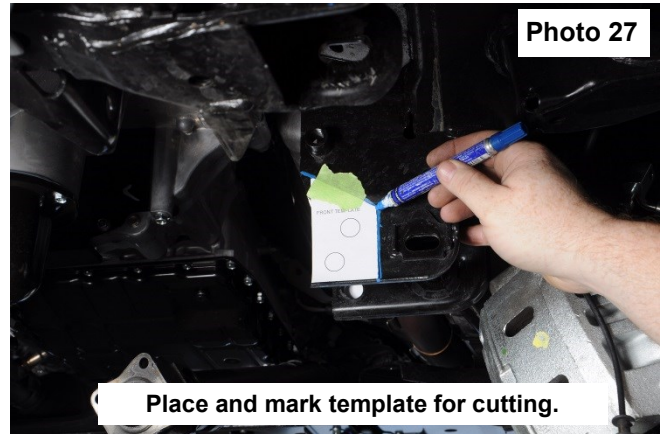

28. Place the supplied cutting template on the rear of the rear driver control arm pocket and mark. **See Photo 28.**
 29. Using a reciprocating saw, cut along the templates or marks on the front and rear of the rear driver control arm pocket. Paint to prevent rust. **See Photo 29.**

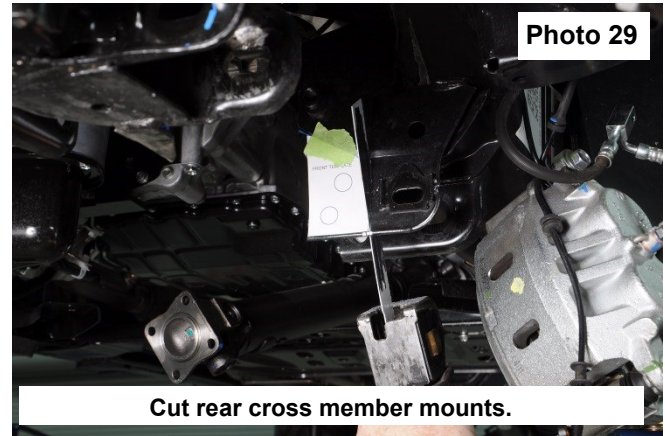
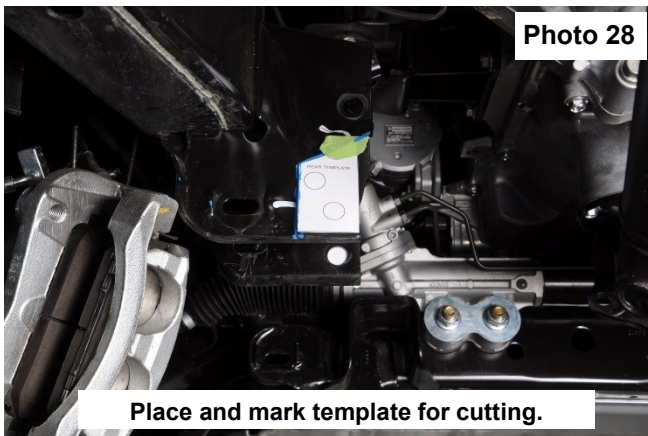

30. Install the front cross member using the supplied 9/16" x 4.5" bolts and hardware from 1878BAG6. **Do Not Tighten.**
 31. Using a jack, install the differential in the new cross member using the factory hardware. **Do Not Tighten.**
 32. Install the rear cross member using the supplied 9/16" x 4.5" bolts and hardware from 1878BAG6. **Do Not Tighten.**
 33. Secure the rear diff mount to the rear cross member using the 9/16" x 4" bolt and hardware from 1878BAG6.
 34. Align the marks made on the driveshaft and install using the factory hardware. Torque to factory specs.
 35. Install the supplied hose and coupler from 1878BAG6 on the diff vent and plug up the diff actuator. **Photo 30.**
 36. Remove the stock bolts from the sway bar mount on the frame on the driver and passenger side. Retain the stock hardware for reuse. Install the supplied sway bar spacers as shown in **Photo 31** between the sway bar and the frame using the factory hardware. **Passenger side shown.**

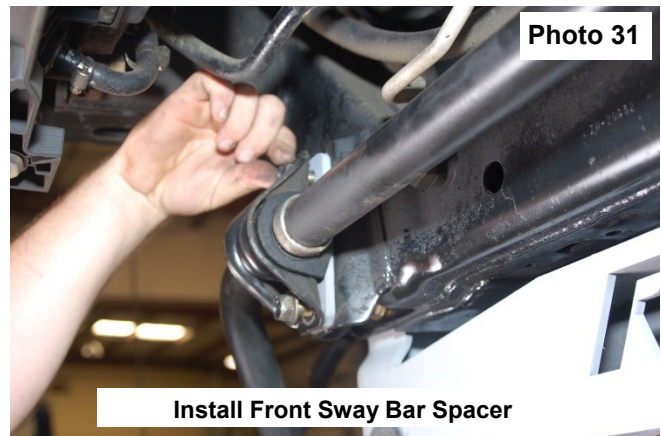

37. Install control arm on truck using supplied cam bolts and hardware. **Photo 32.**
38. Remove bump-stop off of control arm using 12mm wrench. Install bump-stop to the new bump-stop ext. (note there is a left and right bump-stop). Then install to control arm using supplied 5/16" x 1" bolts/washers & nuts from 1878BAG6. Tighten using 13mm wrench. **Passenger side shown in Photo 33.**

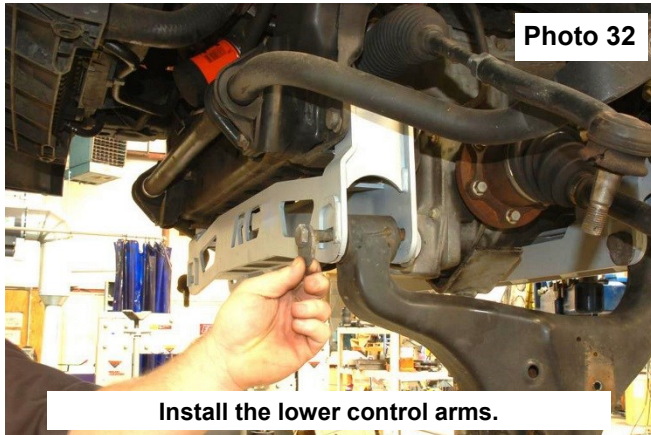

39. At this time tighten all cross-member bolts and differential bolt (4WD ONLY) using 21mm, 22mm and 19mm wrench per torque specs for bolt size.
40. Install the sleeves into the supplied sway bar links then install on the sway bar and control arm using 19mm wrench and the supplied 12mm x 65mm bolts, washers and flange lock nuts from 1875BAG5. ****Note bolt direction in Photo 34. Secure bolt and tighten nut only.**
41. Locate the lower passenger side strut mount part number 94003843. **See Photo 35.**

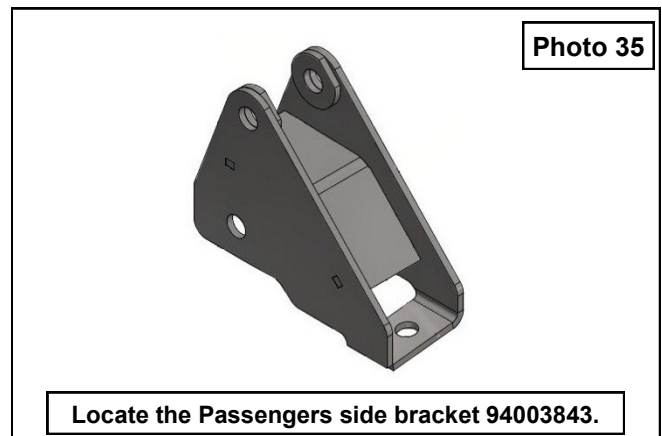
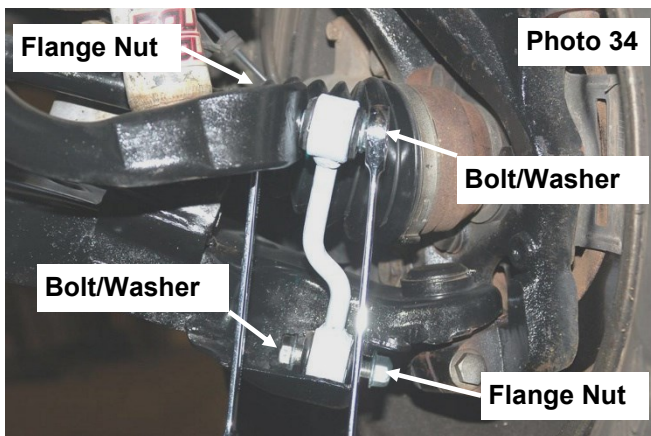

42. Install the supplied lower strut mount to the lower control arm by attaching to the lower strut mount using the 14mm x 80mm bolt and hardware from 1878BAG2. Mark the rear hole on the control arm for drilling and remove the bracket. **Photo 36. These are Dr and Pass side specific.**
43. Drill the marked hole using a 17/32" drill. **Make sure to drill all the way through the control arm.** Paint to prevent rust. **Photo 37.**

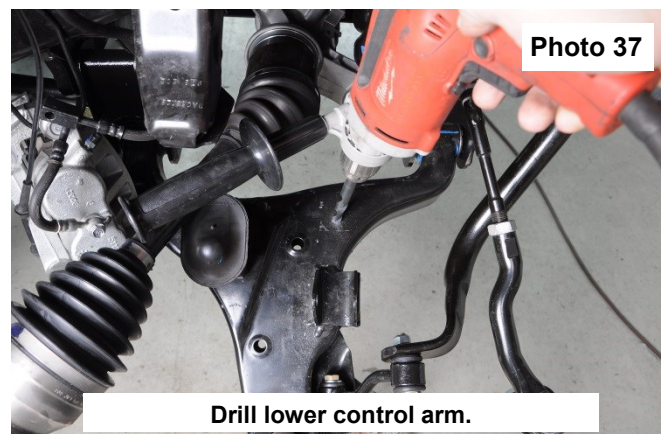
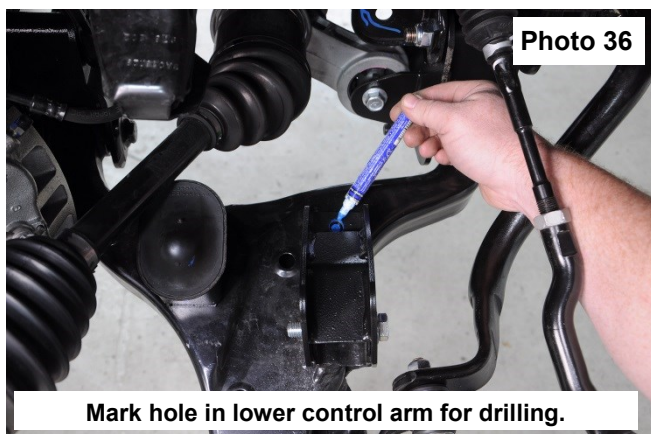

44. Install the lower strut bracket using the supplied sleeve and 14mm x 80mm bolt and hardware from 1878BAG2. Torque to 100ft-lbs using 21mm sockets. **Photo 38.**
45. Attach the bracket to the lower control arm using the supplied 1/2" x 3.5" bolts and hardware from 1878BAG2. Torque to 80 ft-lbs. **Photo 39.**
46. Reinstall axle shafts using 14mm socket and factory hardware. Torque to factory specs.

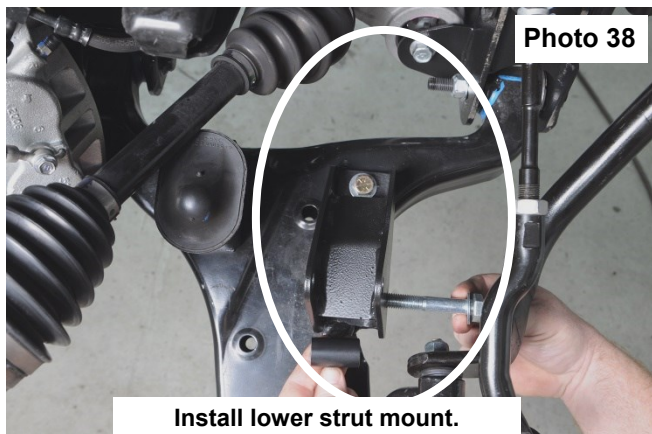

Install lower strut mount.

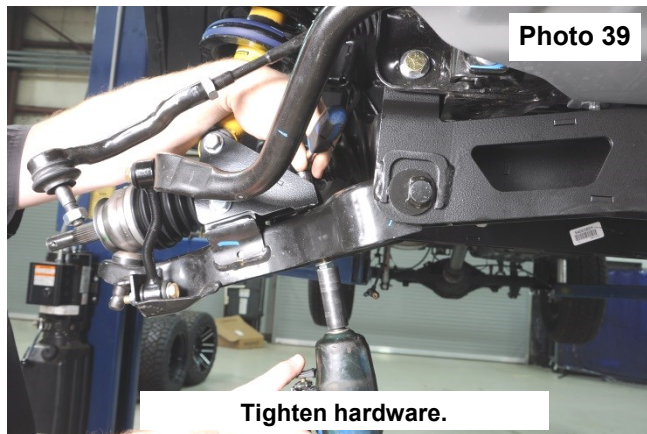

Tighten hardware.

47. Install the supplied 10mm studs on the strut spacer using a 1/2" jam nut, from 10MMSTUDBAG-1, to pull in the stud.
48. Install strut spacers on the stock strut **with shorter side closest to the frame rail.** See **Photo 40.** Tighten using stock hardware with a 14mm wrench.
49. Install the strut assembly on truck using the supplied 10mm nuts & lock washers from 10MMSTUDBAG-1 on the upper strut spacer and stock hardware in lower control arm strut mount as shown in **Photo 41.** It may be necessary to use jack stand to install the lower bolt. Tighten using a 17mm wrench and 19mm wrench. Torque to factory specs.



Install Strut Spacer on Strut with Shorter Side to Inside

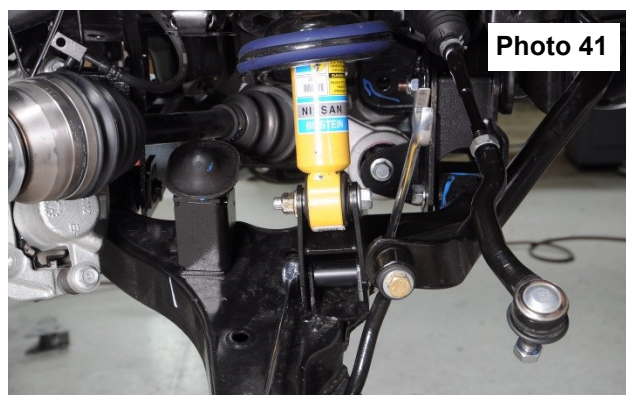

Install Strut Assembly On Lower Control Arm

50. Remove the wheel bearing assembly from the stock knuckle as shown in **Photo 42** using a 21mm socket. Note it may be necessary to heat slightly to break factory lock tight. Retain the factory hardware.

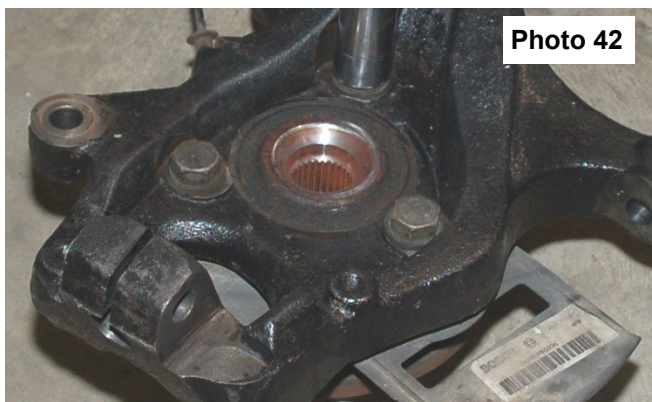

Remove Wheel Bearing Assembly from Stock Knuckle



51. Install wheel bearing assembly into new knuckle as removed from the stock knuckle using factory hardware.
Factory dust shield will be used on new knuckle assembly. See Photo 43.
52. Install knuckle onto truck using stock hardware on the lower ball joint and upper ball joint **See Photo 44. Note:** The upper control arm will pull down at full droop until it makes contact with strut tower—this is as designed and not a problem. Be sure to line up the splines on the axle shaft with the splines on the knuckle/bearing assembly.
53. Torque the lower ball joint to **130ft/lbs** with a 19mm and a 17mm wrench.

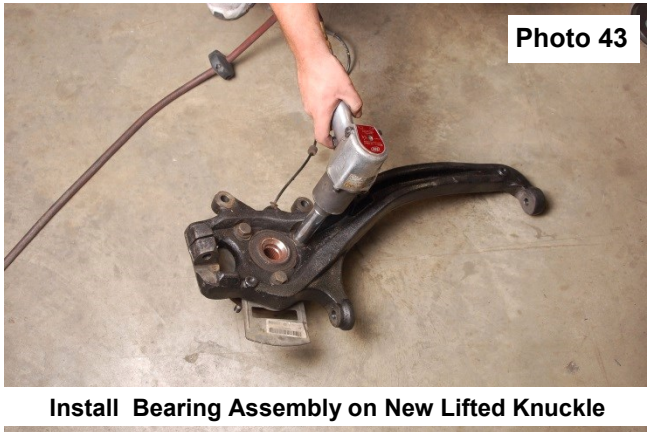

54. Tighten upper ball joint with 22mm wrench.
55. The driver side and passenger side tie rod ends need to be exchanged to provide adequate tire clearance. The stud will be facing down. Install them on the new knuckle using a 22mm wrench with stock hardware.
56. Tighten axle nut with stock hardware using a 32mm socket.
57. Remove the brake line block as shown using a 10mm socket and remove the brake line clip securing the brake line to the frame mount. **See Photo 45.**
58. Using a cutting tool, cut the factory bracket as shown to release the brake line. **See Photo 46.**

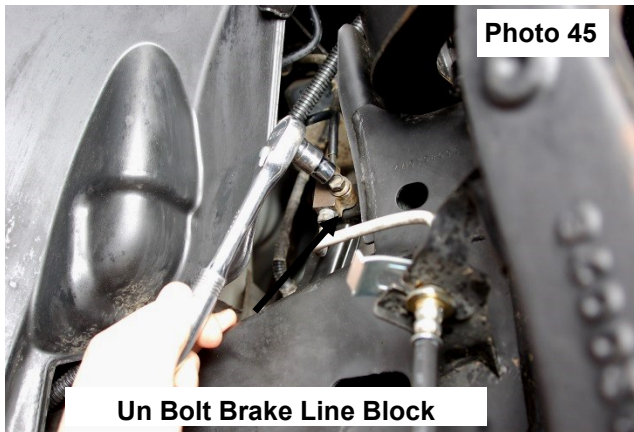

59. Install the supplied brake line bracket using the supplied 3/8" x 1" bolts, washers and nuts and install the brake line in the new bracket as shown in **Photo 47.**
60. Install ABS wire back into bearing using a 5mm Allen socket. Install the brake line on the knuckle using a 13mm wrench. Install brake rotor / brake caliper assembly using stock hardware. Tighten using a 18mm wrench. **See Photo 48.**

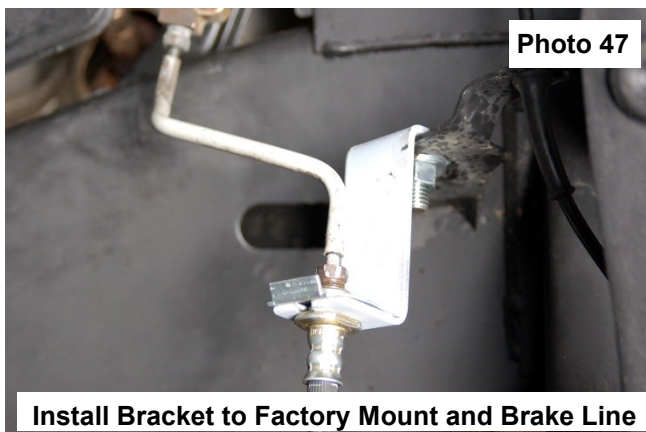

61. Install supplied cotter keys on the upper ball joint and tie rod ends. **See Photo 48.**
62. Install skid plate using supplied 3/8 x1" bolts, from 1878BAG6, on the front and rear cross member. Tighten with a 14mm socket. **Rear cross member shown in Photo 49.**
63. Tighten lower control arm bolts using 22mm wrench.

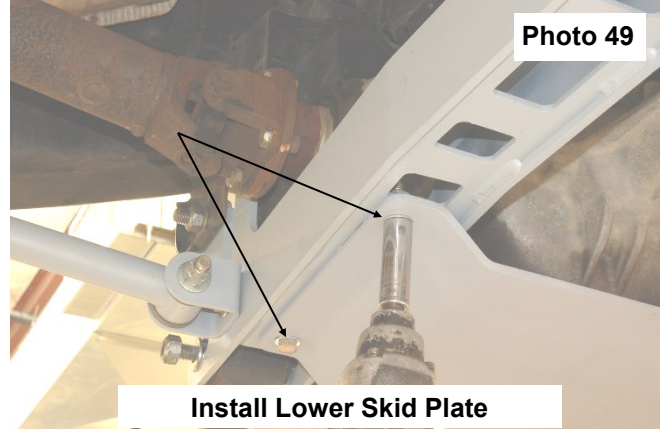
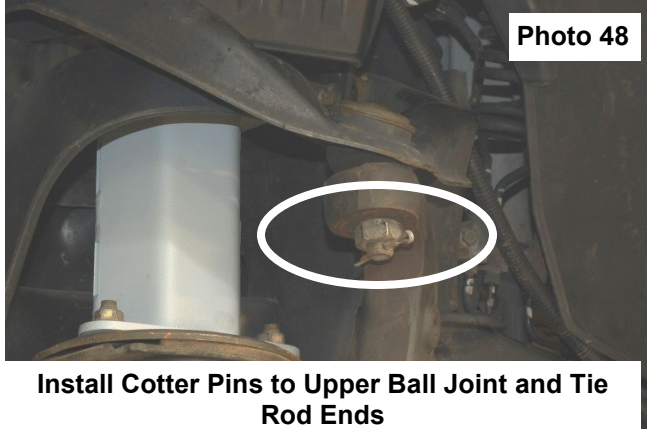

OPTIONAL EQUIPMENT

Rough Country offers a set of kicker braces that add stability to the frame for off road performance. Please contact your Rough Country distributor to order.



REAR INSTALLATION INSTRUCTIONS

If the vehicle is equipped with an electric locker, it will be necessary to free the line from the differential and reroute to allow slack in the line. The lines can be secure with a zip tie to keep them out of harms way.

1. The next 2 steps will be performed with the vehicle on the ground. This is done to ensure adequate brake line length when installing the rear blocks.
2. Remove brake lines from the brake line bracket on the axle using 12mm wrench and install new bracket in the stock location using supplied 8mm x 25mm bolts /washers, from 1878BAG3, with 12mm wrench to secure the bracket to the axle. Relocate the stock brake lines to the top of the new bracket and secure with the supplied 5/16" x 1 1/4" bolts, washers & nuts. **See Photo 1.** Tighten with 13mm wrench.
3. Remove the 2 emergency brake cables from the frame using a 12mm wrench and install the new bracket to the stock location using factory hardware. Relocate the e-brake cables to the bottom part of the bracket as shown in **Photo 2** and secure using the supplied 5/16" x 3/4" bolts, washers /nuts, from 1878BAG3. Secure with a 13mm wrench.

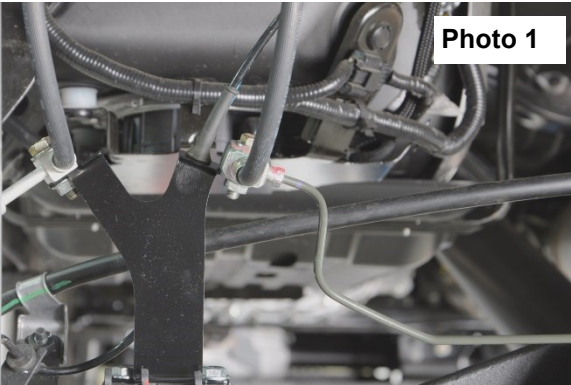

Install Rear Brake Line Bracket Off Rear Axle



Install Rear E Brake Line Bracket To Rear Frame

4. Install the supplied 3/16" vent tube extension and connector from 1878BAG3
5. Chock the front tires and lift the rear of the vehicle, position jack stands under the rear frame rails of the vehicle and lower the vehicle on to the jack stands.
6. Place a floor jack in position under the rear differential for support.
7. On the pass side, remove the push pin holding the inner fender. **Photo 3.**
8. Using a Phillips head screwdriver remove the screw holding the inner fender. **Photo 4.**
9. Remove shocks using 19mm wrench for upper and lower bolts. Retain stock hardware.
10. With slight pressure on the rear axle, remove U-bolts using a 22mm socket.



Remove push pin from inner fender.



Remove screw from inner fender.

11. Remove the rear sway bar links using an 18mm wrench. **Photo 5.**
12. Install the new shocks in the upper mount using the factory hardware. Torque to factory specs. **Do not connect to axle at this time.**
13. Replace inner fender and hardware.
14. Lower the axle down to install the supplied blocks.
15. Remove the upper spring plate. **Photo 6.**

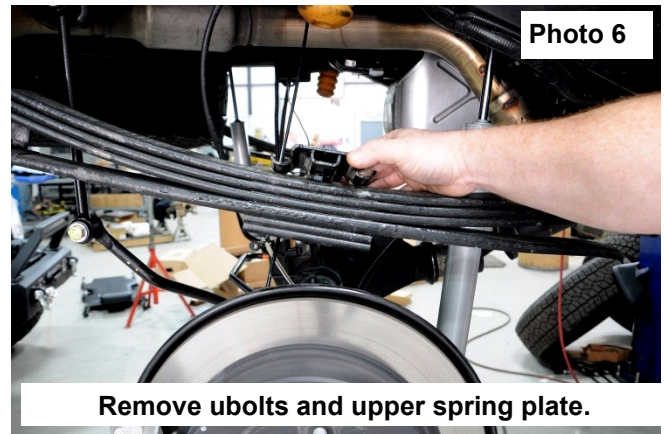

16. Using clamps to hold the leaf pack together, remove the mini leaf pack using a 14mm socket. **Photo 7.**
17. Install the supplied center pin and hardware from 6107BAG, using a 14mm socket. **Photo 8. Cut excess center pin with a reciprocating saw or hacksaw.**

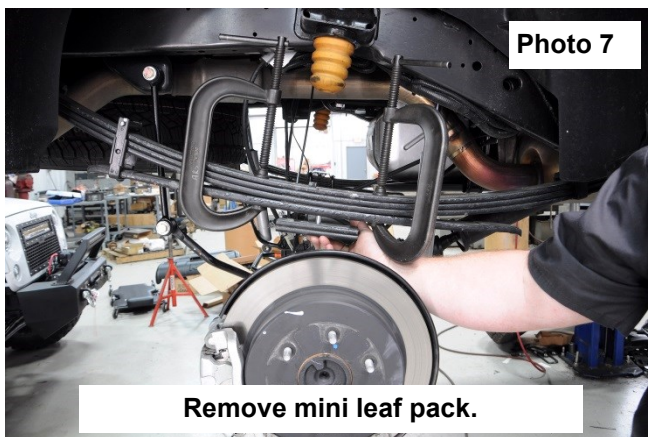

18. Install supplied blocks with the taller end to the rear. Install the supplied 9/16" and 7/16" ubolts. Tighten using 7/8" and 5/8" sockets. **Photo 8.** Torque the 9/16" to 90ft-lbs and 7/16" to 45 ft-lbs.
17. Install the new sway bar links using the supplied 12mm x 65mm bolts, washers, and nuts from 1878BAG3. **Photo 9.**

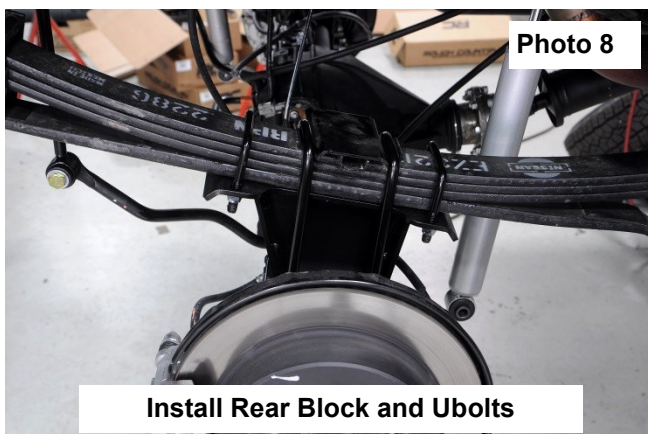

18. Install the shock into the lower mount using the factory hardware. Torque the upper and lower bolts, using 19mm and 21mm wrenches, to factory specs. **See Photo 10.**
10. Install the wheels/tires. Jack up the vehicle and remove the jack stands and lower the vehicle to the floor.

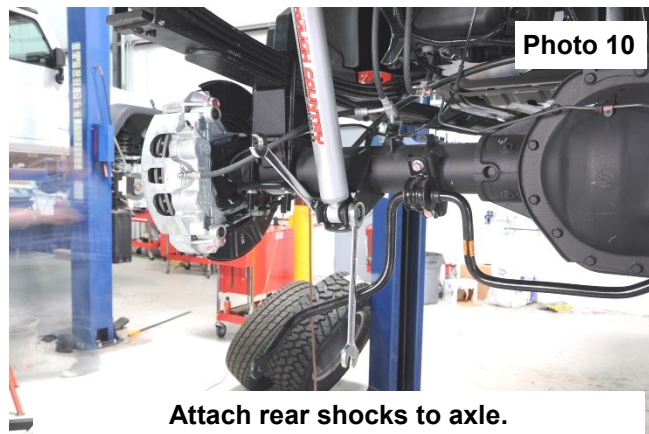

POST INSTALLATION INSTRUCTIONS

1. Check all fasteners for proper torque. Check to ensure for adequate clearance between all rotating, mobile, fixed, and heated members. Verify clearance between exhaust and brake lines, fuel lines, fuel tank, floor boards and wiring harness. Check steering gear for clearance. Test and inspect brake system.
2. Perform steering sweep to ensure front brake hoses have adequate slack and do not contact any rotating, mobile or heated members. Inspect rear brake hoses at full extension for adequate slack. Failure to perform hose check/replacement may result in component failure.
3. On some vehicles the front lower skirting will need to be trimmed if using certain wheel /tire combinations and with heavy offset wheels. Trim only as needed.
4. Have a qualified alignment center align the vehicle immediately. Realign to factory specifications. Perform head light check and adjustment to proper settings.
5. Check and retighten wheels at 50 miles and again at 500 miles.
6. All kit components must be retightened at 500 miles and then every three thousand miles after installation. Periodically check all hardware for tightness.
7. Install "Warning to Driver" decal on sun visor
8. Note: Installation of larger tires will require speedometer recalibration.

By purchasing any item sold by Rough Country, LLC, the buyer expressly warrants that he/she is in compliance with all applicable, State, and Local laws and regulations regarding the purchase, ownership, and use of the item. It shall be the buyers responsibility to comply with all Federal, State and Local laws governing the sales of any items listed, illustrated or sold. The buyer expressly agrees to indemnify and hold harmless Rough Country, LLC for all claims resulting directly or indirectly from the purchase, ownership, or use of the items.



Front bumper spacers.

1. Using a 12mm socket and 8mm Allen to remove the skid plate. **See Photo 1**
2. Using a flat screwdriver, pry the parking sensor bezels out of the 4 clips (each side). **See Photo 2.**



3. Unplug the parking sensors. **See Photo 3.**
3. Using a 12mm socket, remove the side bumper bracket bolts. Save for reuse. **See Photo 4.**

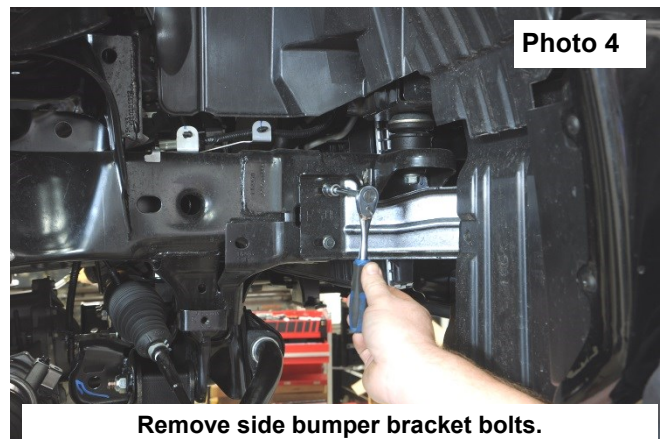

4. Mark the bumper mounting bolts for a reference when reinstalling. **See Photo 5.**
5. Using a 14mm socket, loosen the 6 bolts holding the bumper to the frame on the front of the truck. **See Photo 6.**
Work on one side at a time to keep from having to completely remove the front bumper.

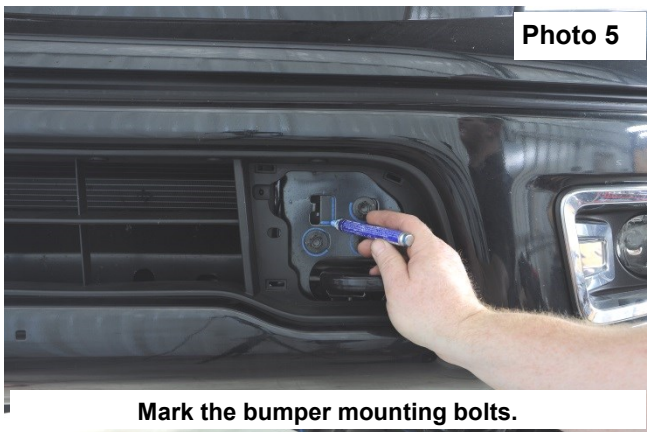

6. Install (2) of the supplied bumper shims into each side of the driver and passenger side of the bumper. **See Photo 7.**
7. Bumper shims shown installed between the frame and bumper. **See Photo 8.**



Install the bumper shims.



Bumper shims shown installed.

8. Attach the bumper using the supplied 10mm x 35mm bolts and washers from 1878BAG6. **See Photo 9.**
9. Align the bumper per your previous marks and tighten using a 17mm socket. **See Photo 10.**
10. Repeat process for opposite side.



Attach the bumper using supplied hardware.



Tighten the bumper bolts.

11. Plug in the parking sensor and push bezel into clips. **See Photo 11.**
12. Install the factory side bumper bolts and tighten using a 12mm socket. **See Photo 12.**



Install the parking sensor bezel.

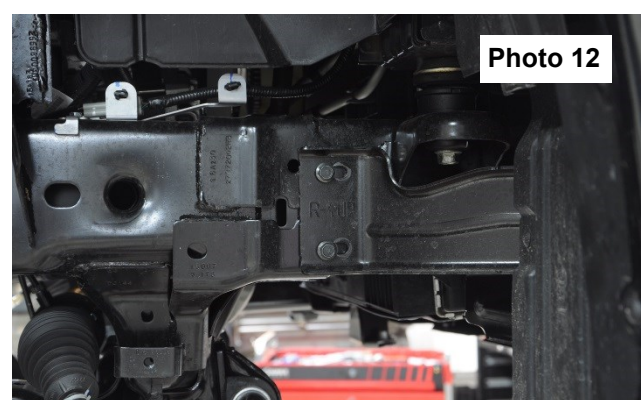

Install the factory side bumper bolts.

13. 2017-19 Models Skip Steps 14-16. Bumper Bracket Fits 2020-Up Models Only.

14. Remove the (4) bolts at the top and the bottom of the passenger side bumper bracket using a 12mm socket. See **Photo 13**. Retain hardware.

15. Remove the bumper bracket from the vehicle. See **Photo 14**.



Remove the 4 bolts from the bracket.



Remove bracket.

16. Install the supplied bumper bracket onto the lower studs. Secure the bracket using the (2) retained bolts in the upper mount and the (2) retained nuts onto the lower studs. Tighten using a 12mm socket. See **Photo 15**.

17. Install the OE skid plate above the crossmember, line up the skid plate to the upper mounting holes and secure using the OE hardware. See **Photo 16**.



Install the bumper bracket onto the OE mount.

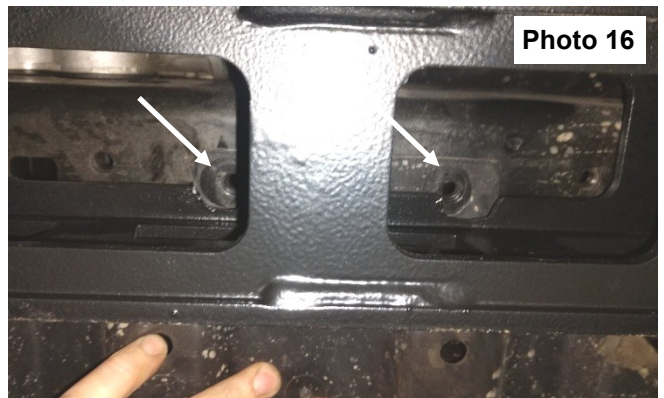

Install the skid plate into the OE mount.

18. Install skid plate using factory hardware and tighten using a 12mm socket and 8mm Allen. See **Photo 17**.

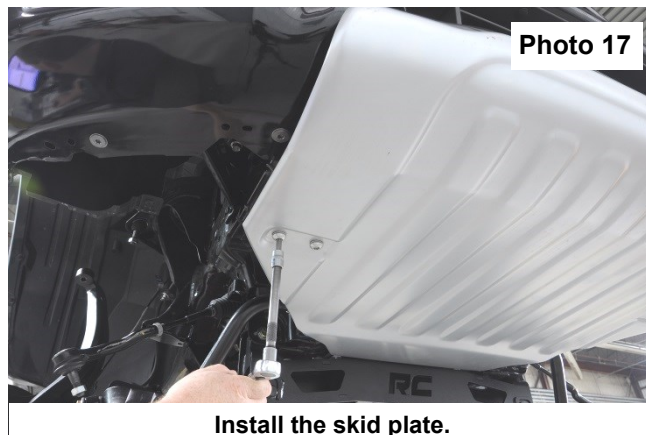

Install the skid plate.

