



FITTING INSTRUCTIONS

Part Number: **5415100**

Product Description: UNDER VEHICLE PROTECTION

Suited to vehicle/s: TOYOTA LAND CRUISER 200 SERIES

Please place these instructions in vehicle glovebox when complete.

WARNING

REGARDING VEHICLES EQUIPPED WITH SRS AIRBAG;

When installed in accordance with these instructions, the vehicle protection panels do not affect operation of the SRS airbag.

ALSO, NOTE THE FOLLOWING:

- ◆ This product must be installed exactly as per these instructions using only the hardware supplied.
- ◆ Do not use this product for any vehicle make or model, other than those specified by ARB.
- ◆ Do not remove labels (if any) from this product.
- ◆ This product or its fixing must not be modified in any way.
- ◆ The installation of this product may require the use of specialized tools and/or techniques
- ◆ These instructions are correct as at the publication date. ARB Corporation Ltd. cannot be held responsible for the impact of any changes subsequently made by the vehicle manufacturer
- ◆ During installation, it is the duty of the installer to check correct operation/clearances of all components
- ◆ Work safely at all times
- ◆ Unless otherwise instructed, tighten fasteners to specified torque

ARB 4x4 ACCESSORIES

Corporate Head Office

42-44 Garden St
Kilsyth, Victoria
AUSTRALIA 3137

Tel: +61 (3) 9761 6622
Fax: +61 (3) 9761 6807

Australian enquiries
North & South American enquiries
Other international enquiries

sales@arb.com.au
sales@arbusa.com
exports@arb.com.au

www.arb.com.au

IMPORTANT INFORMATION. GENERAL CARE AND MAINTENANCE

By choosing ARB vehicle protection, you have bought a product that is one of the most sought after 4WD products in the world. Your under vehicle protection panels are a properly engineered, reliable, quality accessory that represents excellent value.



- While these panels have been engineered for strength and functionality care and good judgment should be taken when traversing difficult off-road conditions to minimise damage to panels and vehicle.
- During servicing when panels are removed ensure fasteners are re-fitted to the correct torque values.
- Inspect panels visually on a regular basis. Dirt and foreign matter should be washed out to minimise build-up around hot components. **BE VERY CAREFUL** when removing foreign matter with hands while vehicle is hot or running. Replace any components as necessary. This service can be performed by your local authorized ARB Stockist.

FITTING REQUIREMENTS

REQUIRED TOOLS FOR FITMENT OF PRODUCT:

BASIC TOOL KIT	
TORQUE WRENCH	

HAVE AVAILABLE THESE SAFETY ITEMS WHEN FITTING PRODUCT:

Protective eyewear	
	Hearing protection

NOTE: 'WARNING' notes in the fitting procedure relate to OHS situations, where to avoid a potentially hazardous situation it is suggested that protective safety gear be worn or a safe work procedure be employed. If these notes and warnings are not heeded, injury may result.

FASTENER TORQUE SETTINGS (unless otherwise specified):

SIZE	Torque Nm	Torque lbft	
M6	9	7	
M8	22	16	
M10	44	32	
M12	77	57	

PARTS LISTING

APPLICATION.	PART NO.	QTY.	DESCRIPTION.
FIT FRONT PANEL	6522956	1	PANEL ASSEMBLY FRONT UVP
	6151300	2	NUT CAGED M6
	4581044	5	WASHER FLAT M8
	4581046	5	WASHER SPRING M8
	6151022	5	BOLT M8x1.25x25
	6151213	2	BOLT M6x1.0x20
	4581287	2	WASHER SPRING M6
	4581082	2	WASHER FLAT M6
FIT DIFF PANEL	6522957	1	PANEL ASSEMBLY DIFF UVP
	4581044	2	WASHER FLAT M8
	4581046	2	WASHER SPRING M8
	6151022	2	BOLT M8x1.25x25
	6151040	2	BOLT M10x1.25x30
	4581048	4	WASHER SPRING M10
	4581040	2	WASHER FLAT M10
FIT TRANSMISSION PANEL	6522958	1	PANEL ASSY TRANSMISSION UVP
	6151040	2	BOLT M10x1.25x30
	6151478	2	NUT FLANGE M10x1.25
	4581040	2	WASHER FLAT M10
FIT TRANSFER CASE PANEL	6522959	1	PANEL ASSY TRANSFER CASE UVP
	6151022	6	BOLT M8x1.25x25
	4581046	6	WASHER SPRING M8
	4581044	6	WASHER FLAT M8
	180302	1	CABLE TIE
FIT TRANSMISSION BRACKET	3759384	1	BRACKET TRANSMISSION UVP
	6151680	4	BOLT M12X1.25X130
	4581049	8	WASHER FLAT ½"
	4581064	4	WASHER SPRING M12
	4581032	4	SPACER
FASTENERS CONNECTING FRONT & DIFF PANEL	4581044	3	WASHER FLAT M8
	4581046	3	WASHER SPRING M8
	6151022	3	BOLT M8X1.25X25
	6151132	2	FLANGE NUT M8X1.25
FASTENERS CONNECTING DIFF & TRANSMISSION PANEL	4581044	3	WASHER FLAT M8
	4581046	3	WASHER SPRING M8
	6151022	3	BOLT M8X1.25X25
	6151132	3	FLANGE NUT M8X1.25
FIT OIL DRAINAGE BRACKET	3759442	1	BRACKET OIL DRAINAGE
	6151256	2	SCREW BTN HD M6
	4581304	2	WASHER FLAT M6
	6151128	2	NUT FLANGE M6

FITTING PROCEDURE – PREPARATION

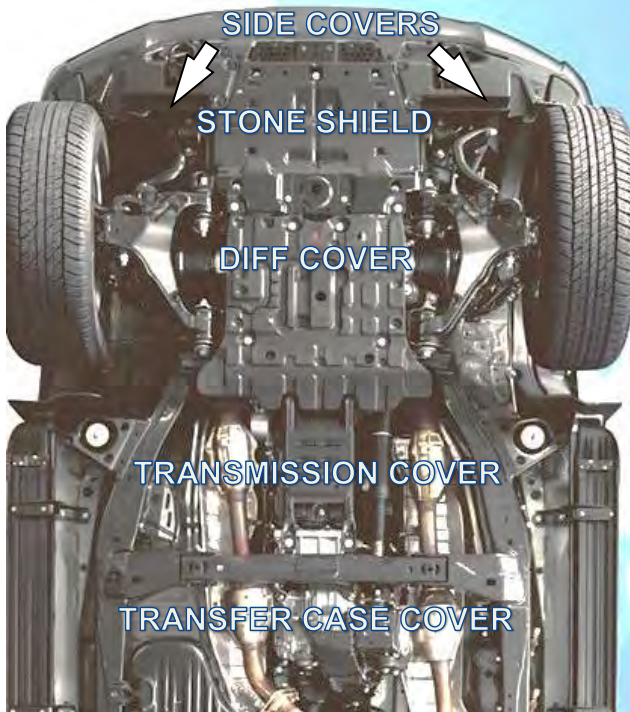

Factory under vehicle protection

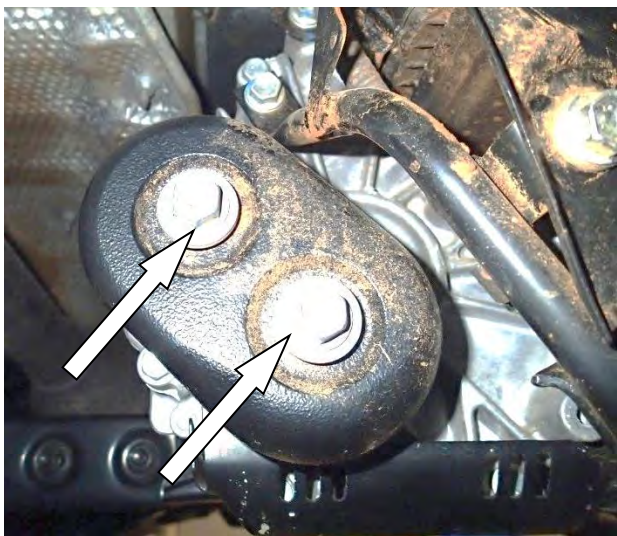

Transfer case dampener

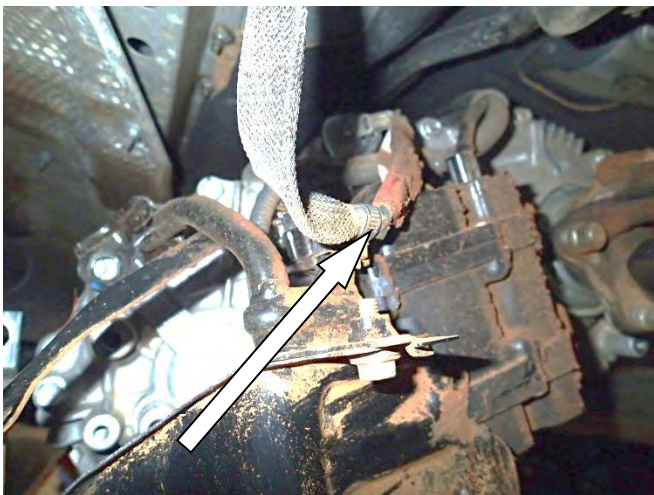

Detach earth cable tie clip

1. Remove factory stone shield from vehicle. (6 bolts)
2. Remove factory side covers surrounding tow hooks if fitted.
Note: If vehicle is being fitted with an ARB bull bar, remove bash plate (6 bolts). Retain four front bolts.
3. Remove factory diff cover. (2 bolts)
4. Remove factory transmission cover. (4 bolts)
5. Remove transfer case dampener. Retain bolts. (2 bolts)
6. Remove factory transfer case cover. (3 bolts front side, 5 bolts rear side)
7. Detach cable tie clip located on earth from OE transfer case cover.

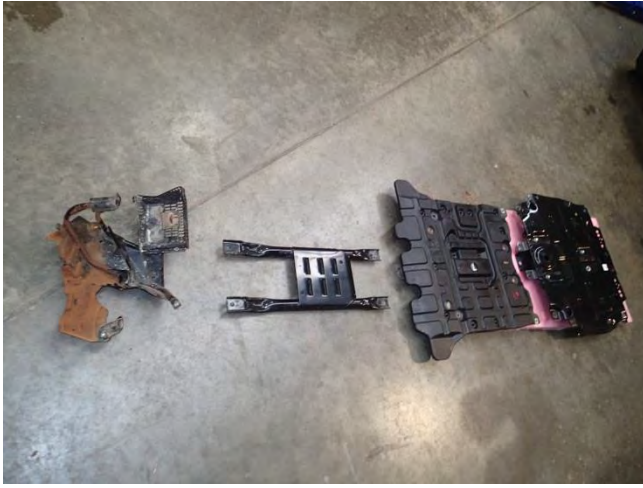

Factory protection removed



Fix earth

8. Cable tie earth to hose positioned above transfer case.

FITTING PROCEDURE – INSTALLATION



Transfer case panel rear side



Transfer case panel front side

9. Fit Transfer case panel to transfer case using M8 hardware outlined in the parts listing on pg3 under 'FIT TRANSFER CASE PANEL'.



M8 - 22Nm



Fit dampener to transfer case

10. Fit dampener back to transfer case using bolts retained from step 5.



M10 PC6.8 – 39Nm



**Fit cage nuts to front panel
(RH shown)**

11. Place 2x M6 cage nuts supplied in front panel cavities.

NOTE: This step is only required for vehicles fitted with an ARB bull bar.

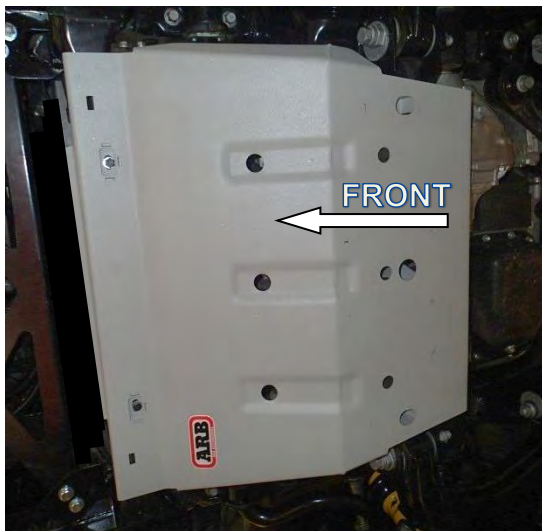

Fit front panel to vehicle

12. Fit front panel to vehicle using M8 hardware outlined in the parts listing on pg3 under 'FIT FRONT PANEL'. Loosely fasten.



Fit front panel to vehicle

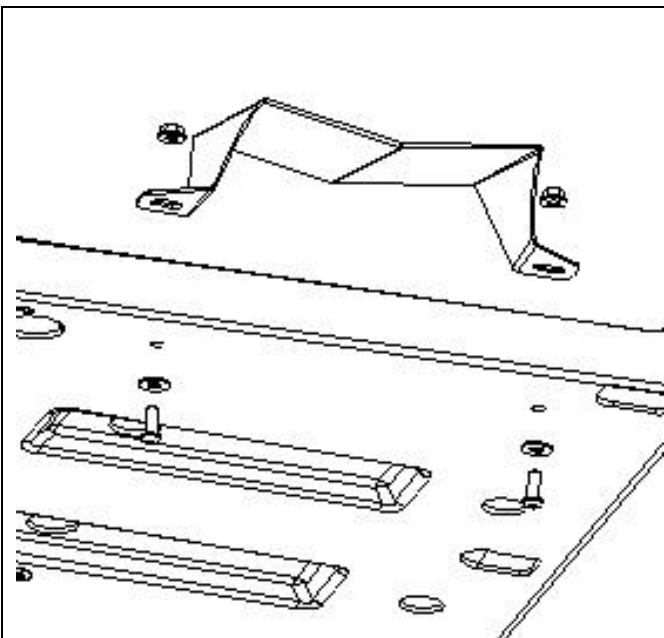

Fasten oil drainage bracket to diff panel

13. Loosely fasten oil drainage bracket to diff panel with slope running downwards towards right side of vehicle. Use M6 fasteners listed on pg 3 under 'FIT OIL DRAINAGE BRACKET'.



Align oil drainage bracket with sump plug bolt

14. Once bracket is aligned with oil sump, tighten fasteners listed in step 13.

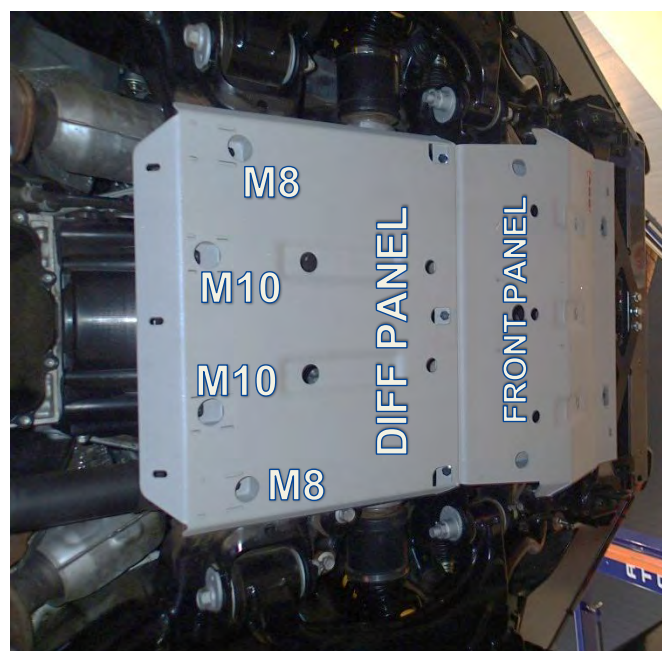

Fit differential panel to vehicle

15. Fit diff panel to vehicle using M8 & M10 hardware outlined in the parts listing on pg3 under 'FIT DIFF PANEL'. Loosely fasten.

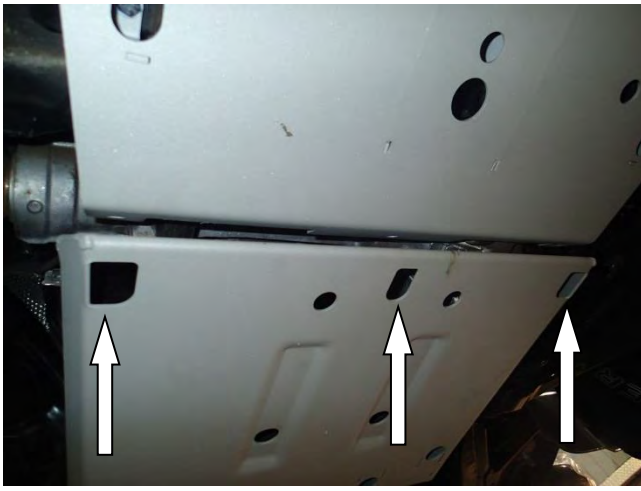

Fasten diff panel to front panel

16. Loosely fasten front panel to differential panel using M8 hardware outlined in the parts listing on pg3 under 'FASTENERS CONNECTING FRONT & DIFF PANEL'.

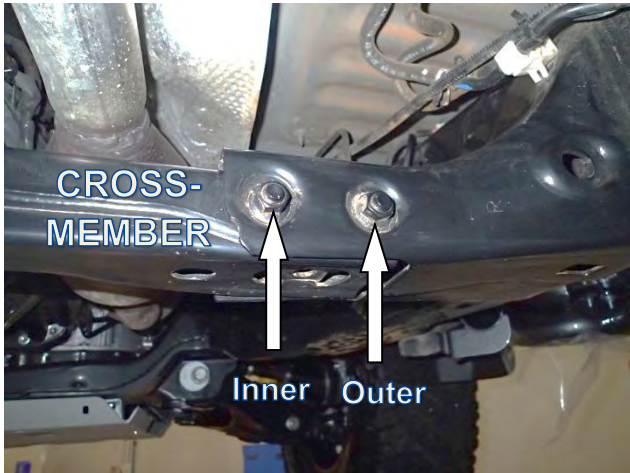

Remove inner bolts

17. Remove 2x inner bolts located in the transmission cross-member.
Place factory nuts aside for re-use.



Support cross-member with a jack stand for extra support.



Position inner bolts

18. Position 2x M12 bolts and washers in place of the inner bolts removed in step 15 outlined in parts listing on pg3 under 'FIT TRANSMISSION BRACKET'.

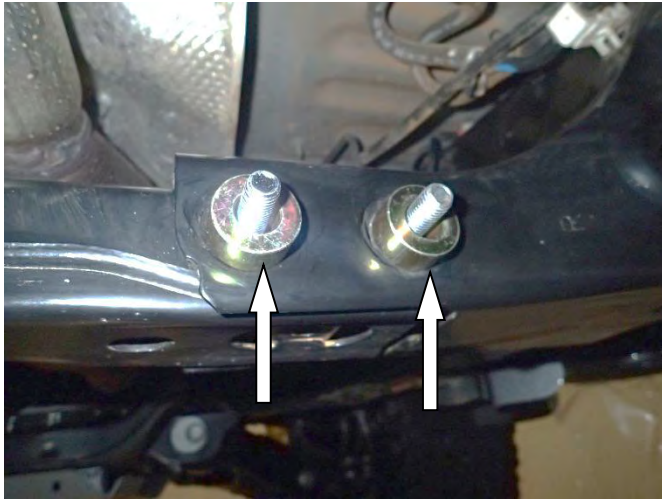

Position outer bolts & spacers

19. Remove 2x outer bolts located in transmission cross-member and replace with 2x M12 bolts and washers. Place factory nuts aside for re-use. Place 4x spacers onto bolts against cross-member.

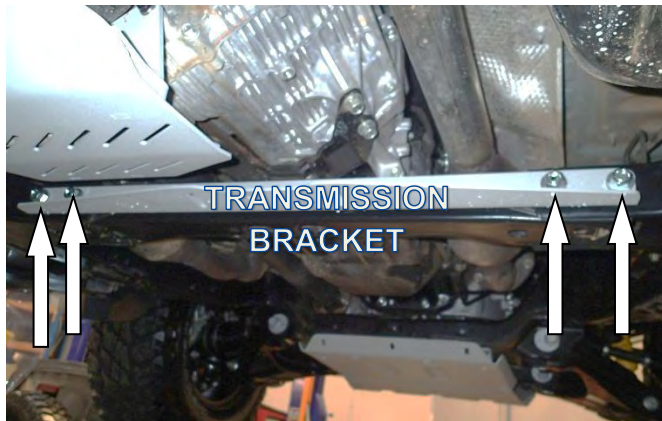

Fit transmission bracket

20. Fasten transmission bracket on loosely using remaining hardware listed on pg3 under 'FIT TRANSMISSION BRACKET' and the factory M12 nuts removed in STEPS 17 & 19.

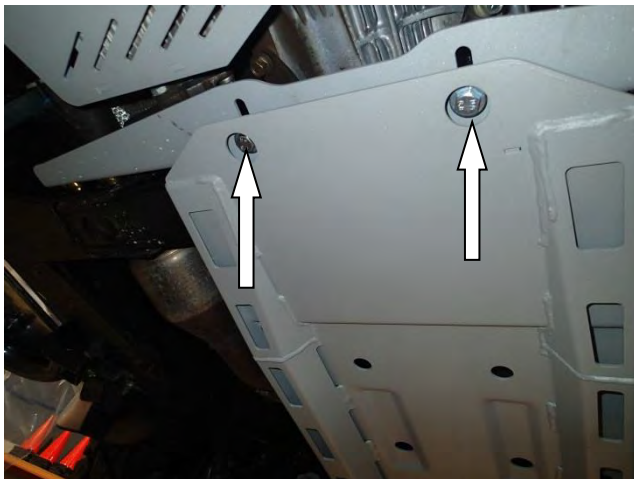

Fit transmission panel

21. Loosely fasten transmission panel to transmission bracket using M10 hardware listed on pg3 under 'FIT TRANSMISSION BRACKET'.



Connect transmission panel

22. Loosely fasten transmission panel to diff panel using M8 hardware listed on pg3 under 'FASTENERS CONNECTING DIFF & TRANSMISSION PANELS'.

23. Tighten all M8 fasteners connecting panels together.



M8 - 22Nm

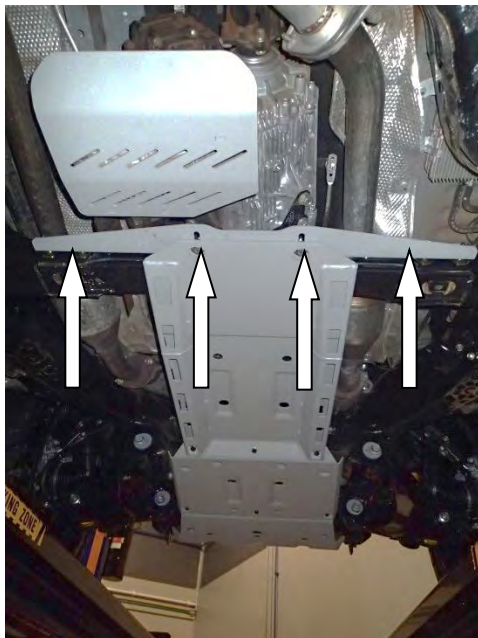

Tighten fasteners transmissison panel

24. Push transmission bracket up as far as possible, then tighten M12 fasteners. Tighten M10 fasteners connecting transmission panel to transmission bracket.



M10 - 44Nm



M12x1.25 - 57Nm

25. Tighten all M8 & M10 hardware used to fix diff panel and front panel to vehicle in steps 12 & 15.



M8 - 22Nm

M10 - 44Nm



Refit bash plate

26. Re-fit ARB bash plate (if fitted) using 4x M6 bolts retained in step 2 during removal together with 2x M6 hardware supplied with kit.



M6 - 9Nm

FITTED PRODUCT



NOTE: ARB bull bar fitted, ARB recovery points fitted.