



Use Instructions Trektop NX Family Window Bag

Vehicle Application:
Jeep® Wrangler 2 Door and 4-Door
Part Number 42815

Installation Tips

Before you use your new Trektop NX Family Window Bag, please read all the instructions thoroughly.

It is normal for the fabric to contract and wrinkle when stored in the shipping carton. Within a few days after installation, the fabric will relax and the wrinkles will disappear.

Please be sure to wash your windows first, before you begin installation.



WARNING

Do not rely in any way on the components of this product to protect against injury or death in the event of an accident. Never operate the vehicle in excess of manufacturer's specifications.

Read and follow, precisely, all installation instructions provided when installing this product. Failure to do so may result in a poor fit and could place occupants of the vehicle in a potentially dangerous situation.

WEAR SEAT BELTS AT ALL TIMES

Support

We're here to help!
Go to www.Bestop.com and
click on "Contact Us"





Use Instructions Trektop NX Family Window Bag

Vehicle Application:
Jeep® Wrangler 2 Door and 4-Door
Part Number 42815

Sugerencias de Instalación

Antes de empezar a instalar esta unidad, lea atentamente todas las instrucciones.

Para un buen ajuste:

Para facilitar la instalación, el producto debe instalarse a temperaturas superiores a 72 °F (22 °C).

Por debajo de esta temperatura, la tela puede encogerse una pulgada o más, lo que dificultaría su ajuste al vehículo.

Es normal que la tela se contraiga o arrugue cuando está guardada en la caja de empaque. A los pocos días después de la instalación, la tela se relajará y las arrugas desaparecerán.



ADVERTENCIA

Este producto se diseñó principalmente para mejorar la apariencia del vehículo y proteger a los ocupantes de las condiciones climáticas comunes. De ninguna manera piense que los componentes de este producto pueden servir como medio de contención para los ocupantes del vehículo o que pueden protegerlos contra lesiones o la muerte en caso de accidente. Este producto no protegerá a los ocupantes contra caídas de objetos. Nunca conduzca este vehículo fuera de las especificaciones del fabricante.

USE LOS CINTURONES DE SEGURIDAD EN TODO MOMENTO

Lea y siga con precisión todas las instrucciones de instalación que se proporcionan para instalar este producto. Si no lo hace, podría producirse un mal ajuste que colocaría a los ocupantes del vehículo en una situación potencialmente peligrosa.



PRECAUCIÓN

Debe usar gafas protectoras en todo momento durante la instalación de este producto.

Conseils pour l'installation

Lire toutes les instructions au complet avant de commencer l'installation de cet assemblage.

Pour un ajustement sans problème :

Afin de faciliter l'installation, ce produit doit être installé à des températures au-dessus de 72 °F (22 °C).

Sous cette température, le tissu peut rétrécir d'un pouce (2,5 cm) ou plus, ce qui rendra l'ajustement sur le véhicule difficile.

Il est normal que le tissu rétrécisse et plisse pendant qu'il est dans la boîte d'expédition. En quelques jours après l'installation, le tissu se détendra et les plis disparaîtront.



AVERTISSEMENT

Ce produit est conçu principalement pour améliorer l'apparence du véhicule et pour protéger les occupants des conditions météorologiques usuelles. Ne jamais se fier aux composants de ce produit pour se protéger de blessures ou de la mort en cas d'accident. Ce produit ne protégera pas les occupants des chutes d'objets. Ne jamais utiliser le véhicule au-delà des caractéristiques techniques indiquées par le fabricant.

PORTER UNE CEINTURE DE SÉCURITÉ EN TOUT TEMPS

Lire et suivre, très fidèlement, toutes les instructions d'installation fournies lors de l'installation de ce produit. Ne pas suivre cette consigne peut causer une installation inadéquate et mettre les occupants du véhicule dans une situation potentiellement dangereuse.



MISE EN GARDE

Des lunettes de sécurité doivent être portées en tout temps lors de l'installation de ce produit.



Use Instructions Trektop NX Family Window Bag

Vehicle Application:
Jeep® Wrangler 2 Door and 4-Door
Part Number 42815

Parts List

- Required parts for installation - Page number in Installation Guide

All Sections

Window Protector Bag

Multiple Pages

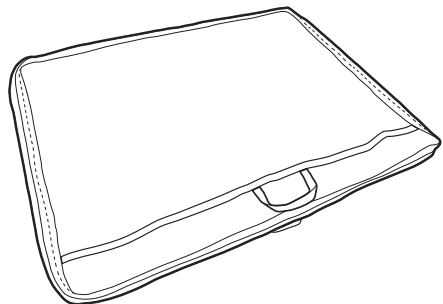

Window Protector Bag
Part #42815
Qty. 1

Note: Please be sure to wash your windows first, before you begin installation.

Step 1

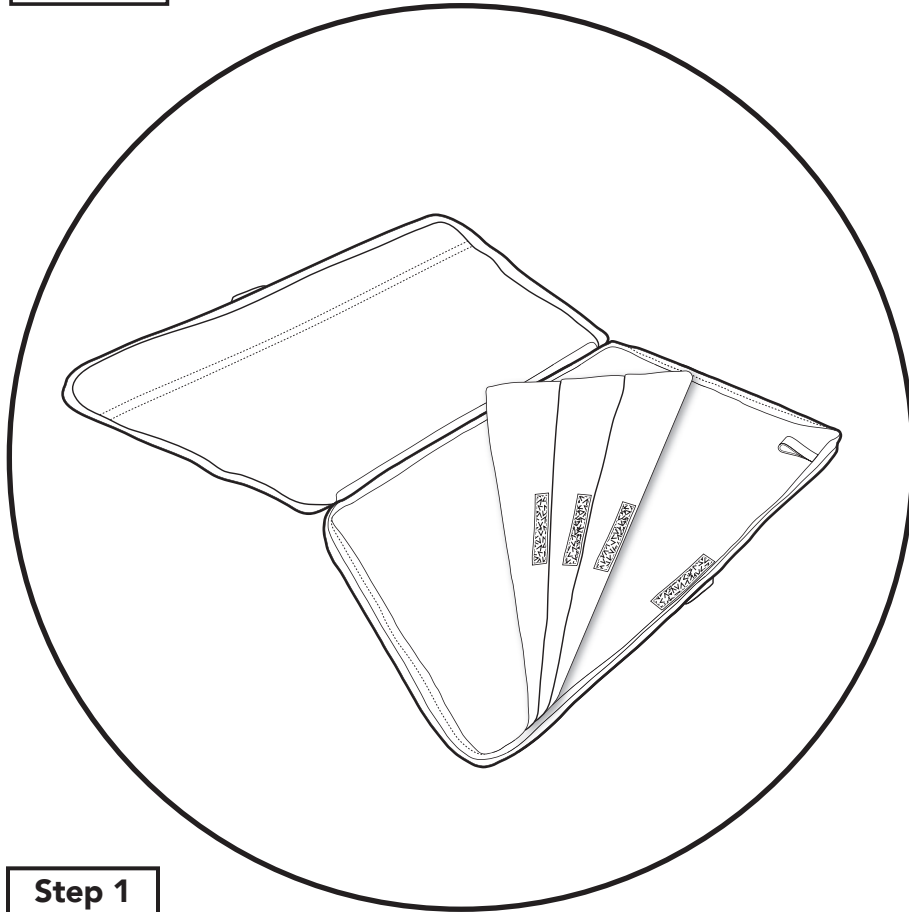

Step 2

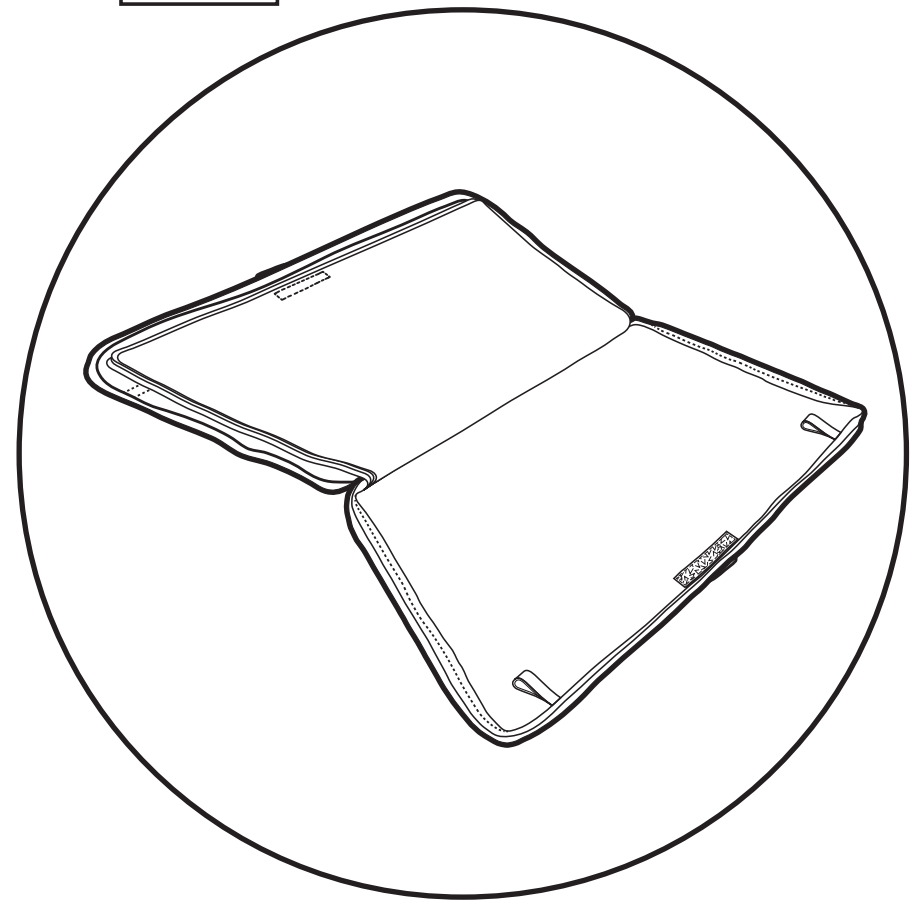

Step 1

Unzip the Window Bag and open it all the way.

Notice the individual protective sheets sewn into the interior of the bag.

Step 2

Flip all but one of the protective sheets over and out of the way.

Leave just one protective sheet lying on the bottom of the open bag nearest to you.

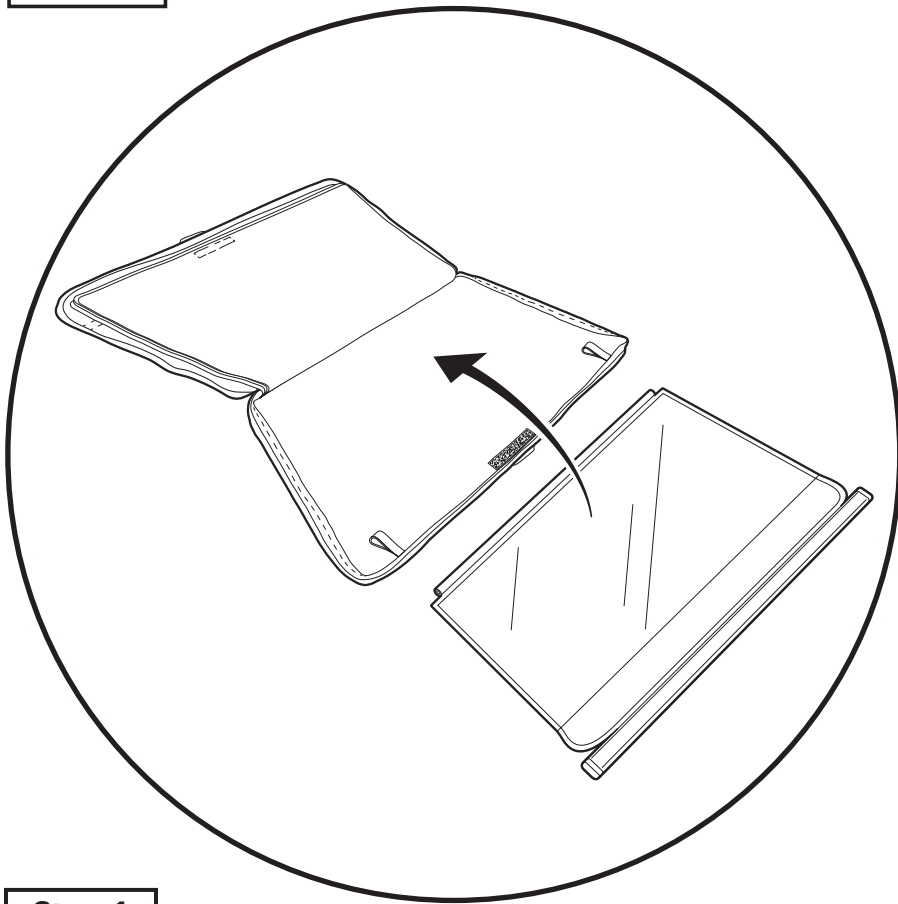
Step 1**Step 1**

Lay the rear window, with the tailgate bar in place, into the Window Bag.

Make sure that the tailgate bar is located on the handle side of the open bag.

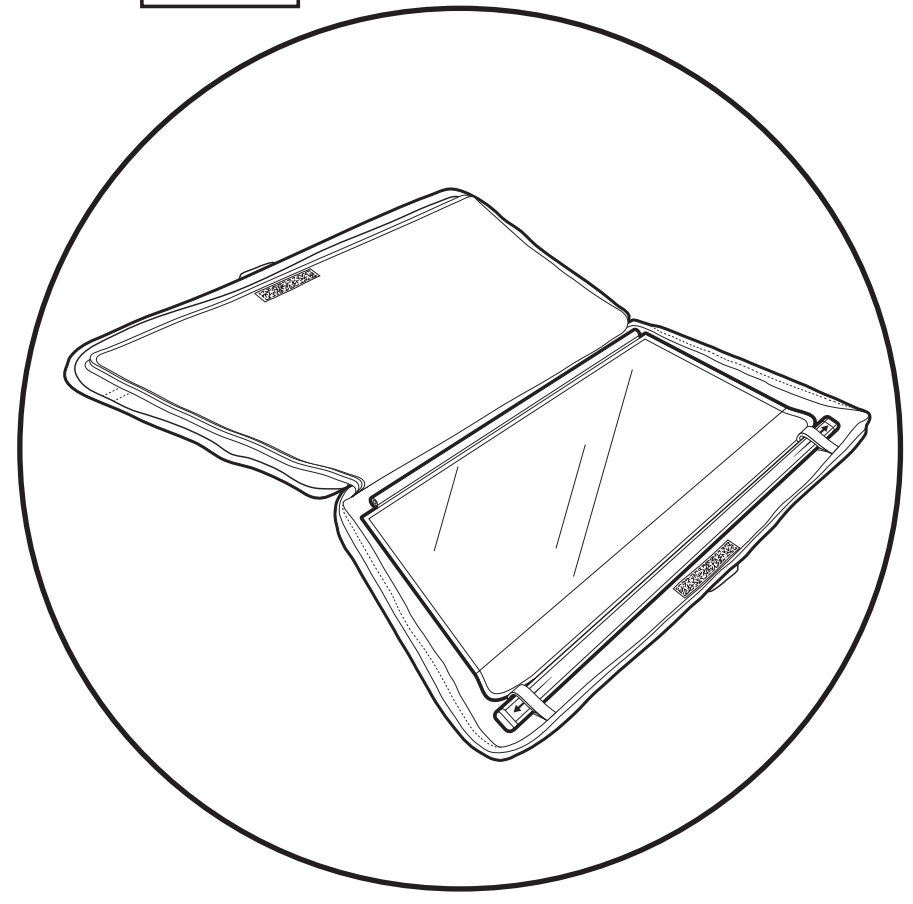
Step 2**Step 2**

Place the sewn-in loop straps over the ends of the tailgate bar.

This will hold the rear window in place inside the bag.

Step 1

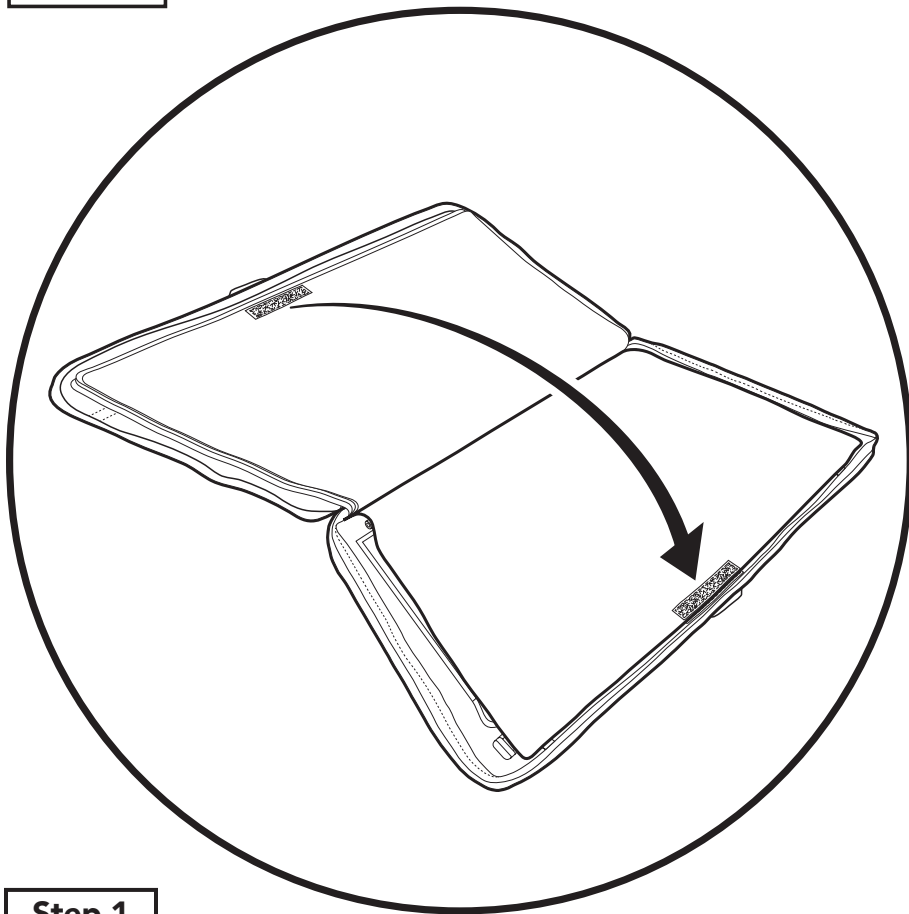

Step 1

Flip one of the protective sheets over, to cover the rear window, and secure the sheet in place using the hook & loop strips sewn into each protective sheet.

Step 2

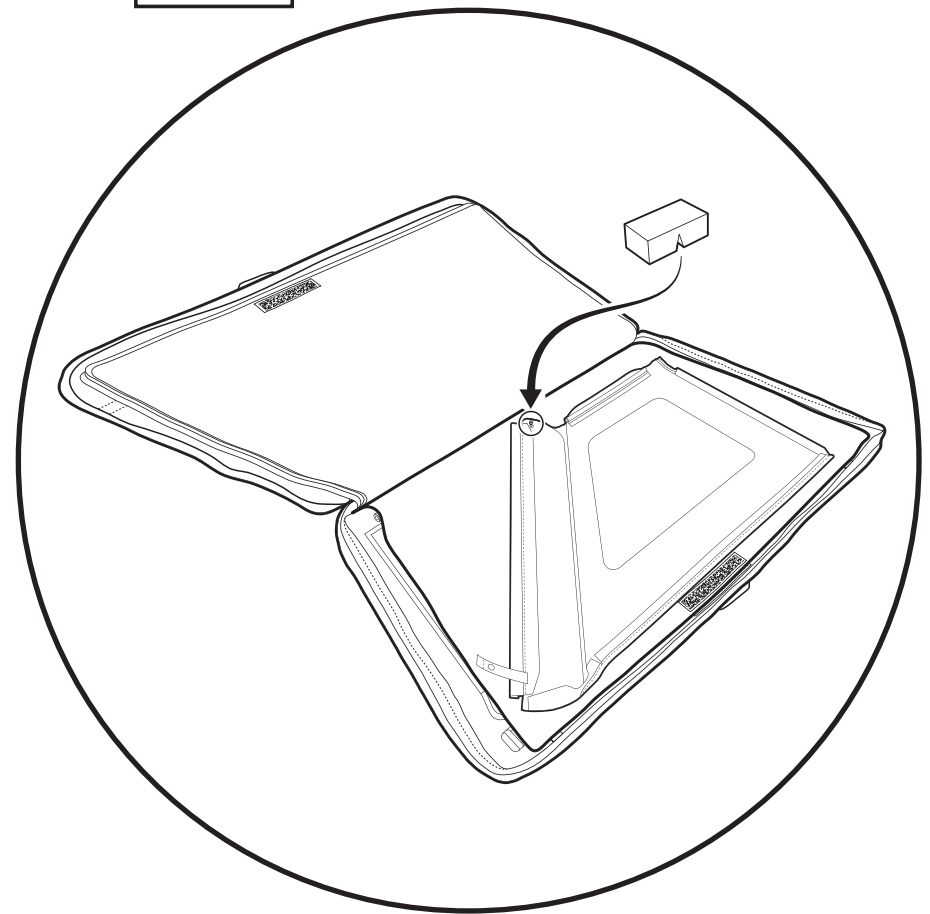

Step 2

Place one of the side windows on top of the protective sheet covering the rear window.

If your side window has a pin at the top rear corner, push the protective foam block over the pin, creating a hole in the foam. This secure fit will protect the sheets from damage to the bag and other windows.

Place the other side window into the bag, between the protective sheets, and secure the sheets with the hook & loop strips.

Step 1

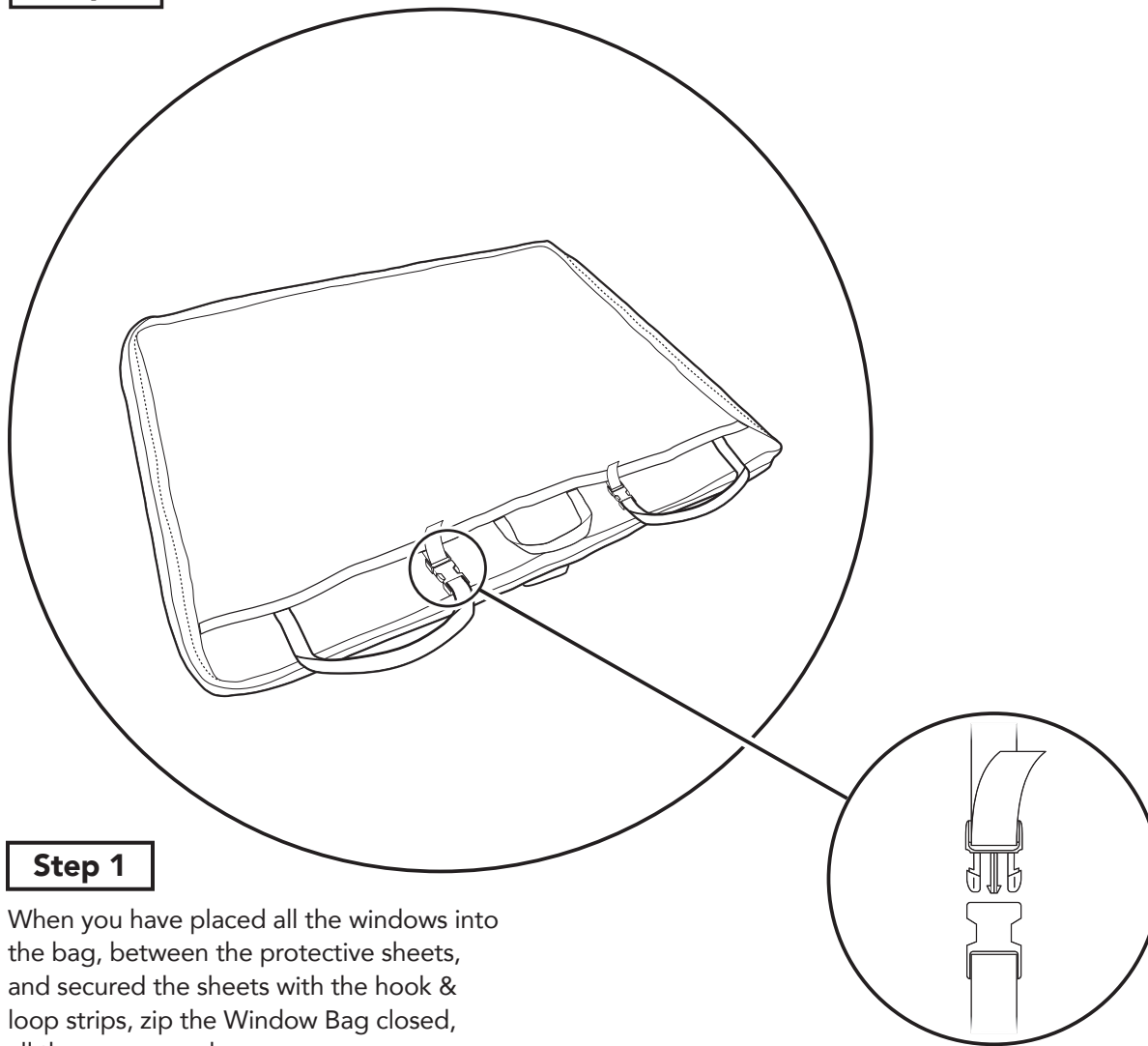

Step 1

When you have placed all the windows into the bag, between the protective sheets, and secured the sheets with the hook & loop strips, zip the Window Bag closed, all the way around.

The sewn-in strap loops with the plastic buckles may be used to hang the Window Bag from the front seats in the Jeep.

Adjust the length of the strap loops to fit your Jeep's seats.



Use Instructions Trektop NX Family Window Bag

Vehicle Application:
Jeep® Wrangler 2 Door and 4-Door
Part Number 42815

Care and Maintenance of your Bestop Product

Your Bestop product is made of the finest materials available. To keep it looking new and for the maximum possible life, it will need periodic cleaning and maintenance.

Fabric: The fabric should be washed often using soap, warm water and a soft bristle brush. Rinse with clear water to remove all traces of soap. Bestop recommends using **Bestop Cleaner** (part no. 11201-00) and **Bestop Twill Protectant** (part no. 11207-00) which are specially formulated to provide a total cleaning and protection system

Windows: Keep windows clean to avoid scratching. DO NOT use a brush on the windows! Wash with a water-soaked cloth or sponge and a mild dishwashing detergent. Bestop recommends Bestop Vinyl Window Cleaner (part no. 11203-00), which safely cleans and protects vinyl windows and helps prevent UV damage. NEVER WIPE THE WINDOWS WHEN THEY ARE DRY. Be careful when cleaning snow or frost from the vinyl windows since they are easily scratched and may crack at low temperatures. DO NOT roll the sides or rear window in cold weather. The windows become stiff and will crack. Cracks caused by misuse in cold temperatures are not covered under warranty.

Zippers: Keeping zippers cleaned and lubricated with Bestop's Zipper Cleaner (part no. 11206-00) will help prevent damage and keep the zippers in smooth working condition. If a zipper opens behind the slider, the slider may have been spread apart. This problem can usually be repaired by using an ordinary pair of pliers to bring the sides back into parallel. Return slider to the end of the zipper in the normal Open position. Squeeze lightly at first and test the zipper. If the zipper continues to remain open squeeze more firmly with the pliers and try the zipper again. Repeat this procedure until the zipper operates correctly.

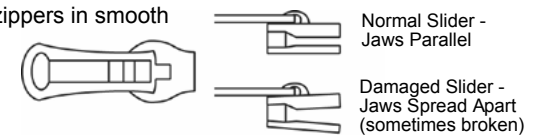

Water: Seeping through at the seams may be stopped by applying 3-M Scotchgard® on the inside of the seams. Rips in the fabric may be repaired with Bondex® iron on patches. Iron the patches to the Inside of the top, carefully following the Bondex® instructions.

Snaps: Keep snaps cleaned and lubricated with silicone to help prevent snaps from sticking to the studs. If a snap does become stuck to a stud, use a screwdriver and GENTLY pry apart to prevent permanent damage to the snap or the top fabric.

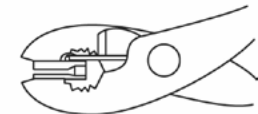



Use Instructions Trektop NX Family Window Bag

Vehicle Application:
Jeep® Wrangler 2 Door and 4-Door
Part Number 42815

Soin et entretien de votre produit Bestop

Votre produit Bestop est fabriqué des meilleurs matériaux disponibles. Il devra être nettoyé et entretenu régulièrement afin de maintenir son apparence neuve et pour une durée d'utilisation maximale.

Tissu : Le tissu doit être lavé régulièrement à l'aide de savon, d'eau chaude et d'une brosse à soies douces. Rincer à l'eau claire afin d'éliminer toute trace de savon. Bestop recommande d'utiliser son **Bestop Cleaner** (pièce no 11201-00) et **Bestop Twill Protectant** (pièce no 11207-00) which qui sont spécialement formulés pour fournir un système complet de nettoyage et de protection.

Vitres : Maintenir les vitres propres pour éviter de les égratigner. NE PAS utiliser une brosse sur les fenêtres. Laver avec un chiffon ou une éponge imbibée d'eau et d'un savon à vaisselle doux. Bestop recommande Bestop Vinyl Window Cleaner (no de pièce 11203-00), lequel nettoie et protégé les vitres de vinyle et aide à prévenir les dommages causés par les UV. NE JAMAIS ESSUYER LES VITRES ALORS QU'ELLES SONT SÈCHES. Prendre soin de bien enlever la neige ou le givre des vitres de vinyle parce qu'elles peuvent être égratignées facilement et peuvent fissurer à de basses températures. NE PAS rouler les vitres latérales ou arrière par temps froid. Les vitres deviennent dures et elles fissureront. Les fissures causées par une mauvaise utilisation par temps froid ne sont pas couvertes par la garantie.

Fermetures à glissière : Maintenir les fermetures à glissière propres et lubrifiées à l'aide du nettoyant Zipper Cleaner (no de pièce 11206-00) de Bestop aidera à protéger des dommages et maintiendra les fermetures à glissière en bon état de fonctionnement. Si une fermeture à glissière ouvre derrière la glissière, la glissière peut avoir été forcée au point de s'ouvrir. Le problème peut habituellement être réparé en utilisant des pinces ordinaires pour remettre les côtés parallèles. Remettre la glissière au bout de la fermeture à glissière, dans la position Ouverte normale. Serrer légèrement au début et vérifier le fonctionnement de la fermeture à glissière. Si la fermeture à glissière continue de rester ouverte, serrer plus fortement à l'aide des pinces et essayer la fermeture à glissière de nouveau. Répéter le processus jusqu'à ce que la fermeture à glissière fonctionne correctement.

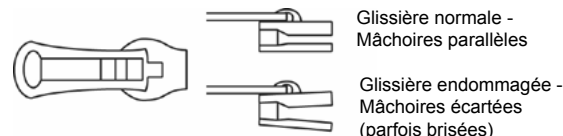

Eau : Les infiltrations d'eau aux coutures peuvent être arrêtées par l'application de Scotchgard® 3M sur l'intérieur des coutures. Les déchirures dans le tissu peuvent être réparées grâce aux pièces thermocollantes Bondex®. Fixer les pièces thermocollantes à l'aide d'un fer à repasser sur l'intérieur du toit, en suivant soigneusement les instructions de Bondex®.

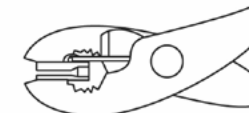

Boutons pression : Maintenir les boutons pression propres à l'aide de silicone pour empêcher les boutons pression de coller aux rivets. Si un bouton pression reste collé à un rivet, utiliser un tournevis et appliquer une FAIBLE PRESSION afin d'éviter d'endommager le bouton pression ou le tissu du toit.

Cuidado y mantenimiento de su producto Bestop

Su producto Bestop está hecho con materiales de la más alta calidad. Para mantener su aspecto nuevo y alargar su vida útil al máximo posible, necesitará limpieza y mantenimiento periódicos.

Tela: debe lavar la tela con frecuencia usando jabón, agua tibia y un cepillo de cerdas suaves. Enjuague con agua limpia para eliminar todos los residuos de jabón. Bestop recomienda usar **Bestop Cleaner** (núm. de parte 11201-00) y **Bestop Twill Protectant** (núm. de parte 11207-00) que están formulados especialmente para proporcionar un sistema de limpieza y protección total.

Ventanas: mantenga las ventanas abiertas para evitar que se rayen. ¡NO use cepillo para lavar las ventanas! Lave con un paño o esponja empapado de agua y un detergente suave para lavar platos. Bestop recomienda usar el limpiador de ventanas de vinilo Bestop (número de parte 11203-00), que limpia de manera segura y protege las ventanas de vinilo, además de ayudar a prevenir daños causados por los rayos UV. NUNCA LIMPIE LAS VENTANAS CUANDO ESTÉN SECAS. Tenga cuidado cuando limpie la nieve o escarcha de las ventanas de vinilo, ya que se rayan con facilidad y pueden agrietarse a temperaturas bajas. NO baje las ventanas laterales o la ventana de la parte posterior cuando haga frío. Las ventanas pueden ponerse rígidas y agrietarse. Esta garantía no cubre las grietas causadas por mal uso en temperaturas frías.

Cremalleras: conserve las cremalleras limpias y lubricadas con el limpiador de cremalleras Bestop (número de parte 11206-00), que ayuda a prevenir daños y mantiene las cremalleras en óptimas condiciones de funcionamiento. Si la cremallera se abre detrás de la corredera, es posible que las mordazas de la corredera se hayan separado. Por lo general, este problema se repara fácilmente con un par de pinzas comunes para volver a poner los lados en paralelo. Regrese la corredera al extremo de la cremallera en la posición abierta normal. Apriete un poco al principio y pruebe la cremallera. Si la cremallera sigue abierta, apriete con mayor firmeza con las pinzas y vuelva a probar la cremallera. Repita este procedimiento hasta que la cremallera funcione correctamente.

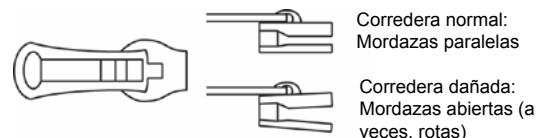

Agua: para eliminar la filtración de agua por las costuras, aplique cinta Scotchgard® de 3-M en la parte interior de las costuras. Los rasgones de la tela pueden repararse con parches Bondex® que se aplican con plancha. Planche los parches en el interior de la capota, siguiendo con cuidado las instrucciones de Bondex®.

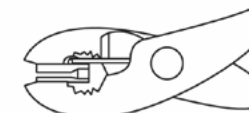

Broches: conserve los broches limpios y lubricados con silicona para evitar que se peguen a los corchetes de encaje. Si un broche se queda pegado a un corchete, use un destornillador y CON CUIDADO separe las dos piezas para evitar daño permanente al broche o a la tela de la capota.



Warranty Information

Vehicle Application:
Jeep® Wrangler 2 Door and 4-Door
Part Number 42815

WHAT BESTOP WARRANTS

Subject to the terms and conditions of sale, including any terms and conditions set forth by Bestop, Inc. ("Bestop" or "us" or "we") in our then-current terms of sale on our website (collectively, the "Terms"), Bestop represents and warrants that: the covered products listed in the "Covered Products and Warranty Periods" section (a "Product") will substantially be free from defects in materials and workmanship for the specified warranty periods set forth in that section.

THE WARRANTY IS LIMITED AND CONDITIONAL

This warranty applies to the original purchaser of the Product only. The warranty is valid only as long as the original retail purchaser owns the vehicle upon which the Product is installed. The warranty expires should the Product be removed from the original vehicle or if the original vehicle is transferred to another owner. This warranty is not transferable or assignable. The warranty does not apply to Product bought from auction-style or price-bid websites.

THE LIMITED WARRANTY AND STATED REMEDIES ARE SOLE AND EXCLUSIVE AND IN LIEU OF ALL OTHER WARRANTIES AND REMEDIES, AND COMPANY EXPRESSLY DISCLAIMS ALL IMPLIED OR STATUTORY OR OTHER WARRANTIES, INCLUDING WITHOUT LIMITATIONS WARRANTIES OF MERCHANTABILITY, NON-INFRINGEMENT OR FITNESS FOR A PARTICULAR PURPOSE. IN NO EVENT WILL COMPANY BE LIABLE FOR ANY SPECIAL, INCIDENTAL, CONSEQUENTIAL, PUNITIVE, INDIRECT OR EXEMPLARY DAMAGES OF ANY KIND, INCLUDING LOST PROFITS OR REVENUE, HOWEVER CAUSED, WHETHER FOR BREACH OR REPUDIATION OF CONTRACT, TORT, BREACH OF WARRANTY, NEGLIGENCE, OR OTHERWISE, WHETHER OR NOT COMPANY WAS ADVISED OF THE POSSIBILITY OF SUCH LOSS OR DAMAGES. *Some states do not allow exclusion or limitation, so this may not apply to you. This warranty gives you specific legal rights, and you may have other rights which vary from state to state.*

EXCLUSIONS TO THE WARRANTY

The Limited Warranty excludes, and Bestop is not liable in any way for any warranty claims, damages, or defects related to:

- Misuse, abuse, accidents, vandalism, negligence, fire, or improper installation or modification, or improper or inadequate maintenance;
- Failure to comply with any Product documentation, Bestop instructions, or applicable law or regulations; use in extreme conditions
- Force Majeure including but not limited to, earthquake, hurricane, tornado, flooding, or other disasters natural or man-made, civil unrest, strikes, declared or undeclared war, or lack of performance by, or discontinued product of, supply chain partners whose products, software, operations or management is beyond the control of Bestop;
- Damage resulting in breakage (including without limitation, spontaneous breakage, accidental breakage or breakage by any other means) of a Product or any component part;
- Damage to vinyl windows due to misuse, or cracking due to varying weather conditions.

YOUR SOLE REMEDY

During the applicable warranty period, Bestop shall, at its option, either repair or replace any Product that it confirms, in its discretion, is non-compliant with the warranties herein. Bestop will not pay for labor charges associated with installation or removal of the Product. Should a specific Product be discontinued, Bestop may, at its option, replace the discontinued Product with a current product or like product. If Bestop opts to repair or replace your Product as set forth herein, Bestop shall use reasonable efforts to match any patch or replacement to the color and texture of your existing Product. There is no guarantee however, that Bestop will be able to match the color or texture. If Bestop is not able to match the color or texture, it may provide you with a black or neutral colored patch replacement in its discretion.

Please retain your proof of purchase. Original proof of purchase for the Product must accompany any warranty claim. If you have a warranty claim, first you must email Bestop Customer Service at csbestop@bestop.com for instructions. All claims must be emailed to csbestop@bestop.com within 30 days of discovery of a defective Product, but in no event later than thirty days after the end of the applicable Warranty Period (the "Warranty Notice Period"). Warranty claims made after the Warranty Notice Period are null and void and Bestop shall have no responsibility with respect to such claims.

THIS SECTION SETS FORTH BESTOP'S SOLE OBLIGATION & YOUR SOLE REMEDY WITH RESPECT TO ANY DEFECTS OR OTHER PRODUCT ISSUE. ANY PRODUCTS REPLACED UNDER TERMS OF THIS WARRANTY WILL BE COVERED UNDER TERMS & BALANCE OF THE DURATION OF THE ORIGINAL LIMITED WARRANTY FOR SUCH PRODUCT.



Warranty Information

Vehicle Application:
Jeep® Wrangler 2 Door and 4-Door
Part Number 42815

COVERED PRODUCTS AND WARRANTY PERIODS: The warranty time periods are as follows for Products manufactured by Bestop:

BESTOP® LIMITED LIFETIME WARRANTY

Trektop® Pro Twill Fabric Top	Sunrider® for Hardtop Twill Fabric Top
Trektop® NX Glide Twill Fabric Top	Replace-a-Top™ Twill Fabric Top
Trektop® NX Twill Fabric Top	Supertop® NX Twill Fabric Top
EZFold™ Soft Tonneaus	Floor & Cargo Liners
ZipRail™ Soft Tonneaus	Pet Barriers
EZRoll™ Soft Tonneaus	

BESTOP® 5-YEAR LIMITED WARRANTY

Trektop® NX Glide™ Top (non-Twill)	Sunrider® for Hardtop
(non-Twill)Replace-a-Top™ Top (non-Twill)	Trektop® NX Top (non-Twill)
Sailcloth Replace-a-Top™	Supertop® NX Top (non-Twill)
Tigertop™ and Halftop™	Supertop® Classic Soft Top
Sunrider® Complete Soft Top	Supertop® for Truck
EZ Fold Hard Tonneau	

BESTOP® 3-YEAR/100K MILES LIMITED WARRANTY

Powerboard® & Powerboard® NX
Trekstep®, Side Mount
Trekstep®, Rear Mount

BESTOP® 3-YEAR LIMITED WARRANTY

Pavement Ends Sprint Top

BESTOP® 2-YEAR LIMITED WARRANTY

Trektop® Classic Soft Top
RoughRider™ Soft Storage

BESTOP® 1-YEAR LIMITED WARRANTY

All other Bestop® & Pavement Ends™ products not specified above.

For further information or request for warranty work, please contact:

Bestop Inc. Customer Service

Toll-Free: (800)845-3567

Main: (303)465-1755

E-mail: csbestop@Bestop.com

Website: www.Bestop.com