



Ford Ranger (2019+)/ Ranger (2021+) Bronco with OE/Capable Bumper Squadron Fog Pocket kit Instructions



2950 Norman Strasse San Marcos, CA 92069

Phone 760-560-2252 X3 • Fax 760-560-0383

info@bajadesigns.com • www.bajadesigns.com



baja designs[®]
The Scientists of Lighting

LIMITED LIFETIME WARRANTY

Baja Designs proudly offers a LIFETIME WARRANTY against manufacturer's defect on all the products that we manufacture.

These are comprehensive warranties; other than the exclusions below – you're covered. If your LED or HID bulb burns out, you're covered. Additionally, cutting off our connector or changing your lenses does not automatically void your warranty.

Exclusions:

Installation errors, abuse, misuse or crash damage. You must be the original owner of the product and can supply proof of purchase.

Baja Designs manufactures its own products as well as resells products manufactured by others. Baja Designs makes no express or implied warranties on products not manufactured by Baja Designs including without limitation any warranties or merchantability and fitness for a purpose. We will, however, pass on all warranties made by the manufacturer, who has sole responsibility for performing such warranties.

Baja Designs will pay the freight if your product is less than 90 days old, otherwise defective products must be returned to Baja Designs, Inc., freight prepaid. At our option, we will repair or replace items in question and return them at no charge. If the identical product is no longer available, we will replace with a similar product of equal value. Baja Designs Inc. will not be responsible for any indirect or consequential damages in connection with defective merchandise.

Items purchased through a Baja Designs authorized dealer must be returned through the dealer. Only available on LED auxiliary lights and product must be in sellable condition at MSRP. Product that has been damaged in any way after the original purchase date will be excluded from this guarantee.

Indemnification:

Buyer hereby acknowledges off-roading, racing and driving at night are dangerous activities and that the products and/or supplies purchased from Baja Designs are used in an inherently dangerous activity that may endanger life and limb; and in no event shall the seller, or seller's heirs and assigns, be held liable for consequential damages, nor shall seller's liability on any claim for damages arising out of or connected with the sale, delivery, or use of purchased products and/or supplies exceed the purchase price of the products and/or supplies

2019 Ford Ranger Squadron Fog Pocket Kit

Tools Required

- T25 Torx bit
- 10mm, 13mm, 15mm, 21mm socket
- Plastic Trim tool or flat head screw driver
- 4mm Allen Wrench

1. Using a 10mm Socket, remove the license plate holder by taking out the (2x) bolts located on the bottom.



2. Remove the (5x) plastic clips located in the lower grill opening.

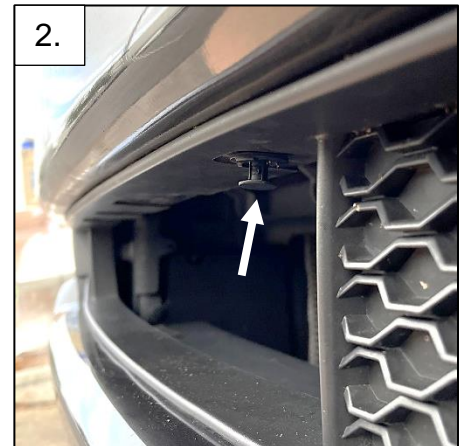

3. If equipped with a skid plate, use a 15mm socket to remove the (4x) bolts. Using a 10mm socket, remove the (5x) bolts located on the bottom side of the bumper.



4. If equipped, unplug the parking sensors located in the lower grill opening by pressing down on the circled release tab. Use the trim tool or flathead to remove the arrowed harness clip.

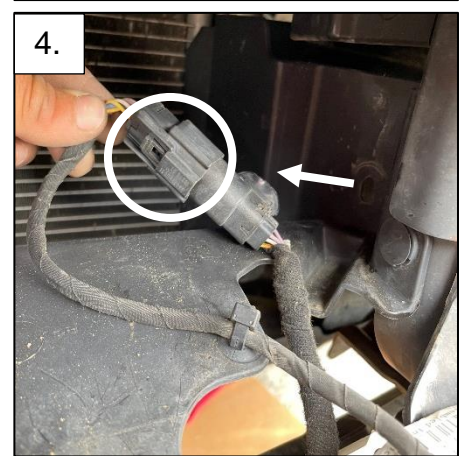

5. Remove the plastic in the lower grill opening by carefully prying on the locations shown.



6. Using a 21mm socket, loosen the (6x) nuts mounting the bumper.



7. With an assistant, support the bumper and remove the nuts. Under the drive side headlight, disconnect the main bumper electrical body connector. Place the bumper aside, face down on a soft work surface.

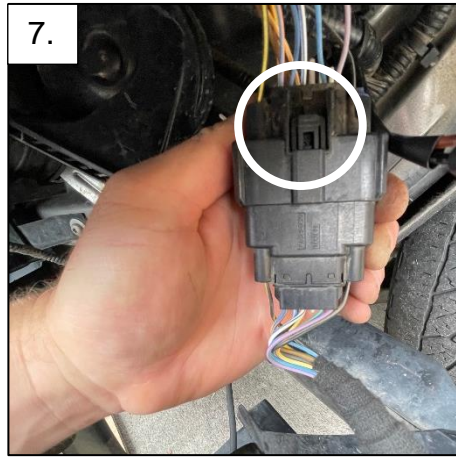

8. Using a 10mm socket, remove the (2x) bolts mounting the plastic splash guard behind each OEM fog light.

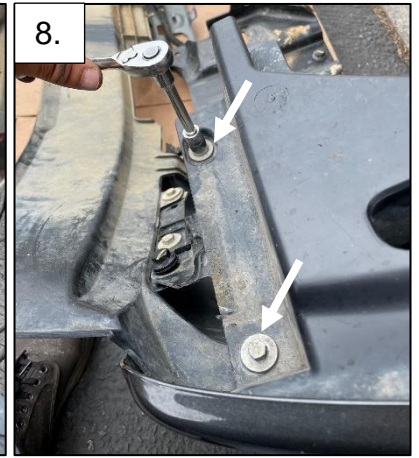

9. Using a 13mm socket, remove the (2x) bolts mounting the support bracket.

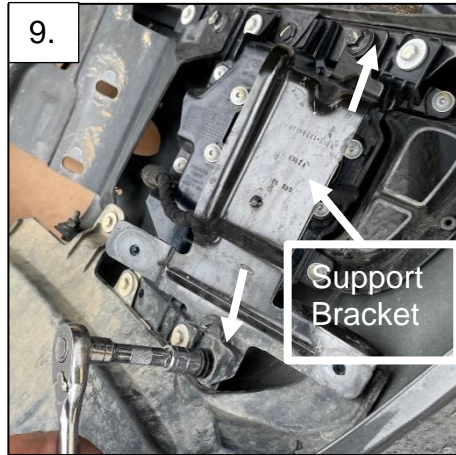

10. Unplug the OEM fog light by pressing in on the locking tab as shown.

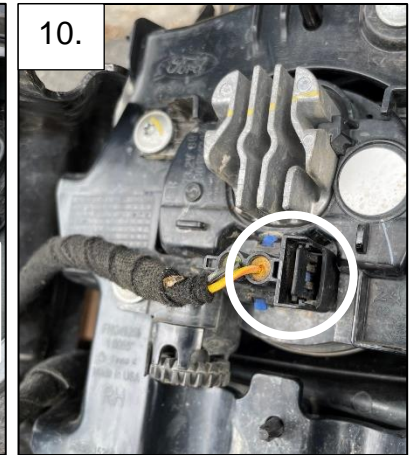

11. Using a T25 Torx Bit, remove the (4x) bolts mounting the OEM fog light.

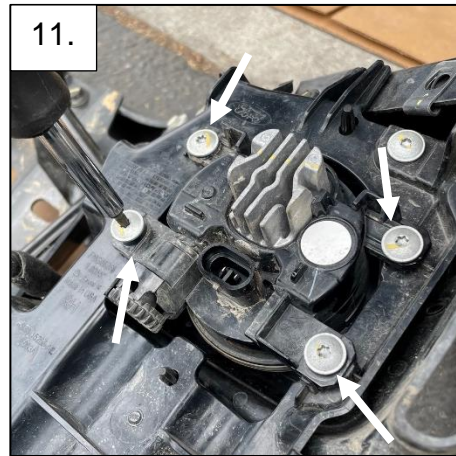

12. Plug in the supplied piggyback adapter harness to the OEM wiring harness.

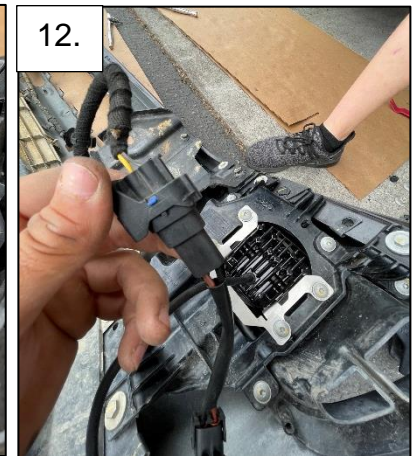

13. Mount the squadron light to the supplied bracket with the bolt stack-up shown.

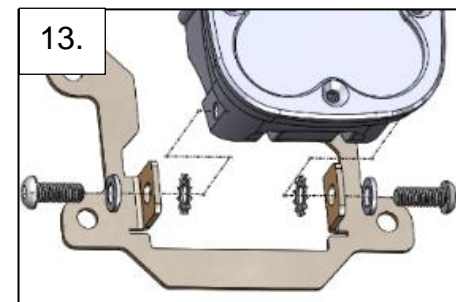

14. Mount the Baja Designs light assembly with the provided spacers in between the light bracket and bumper.

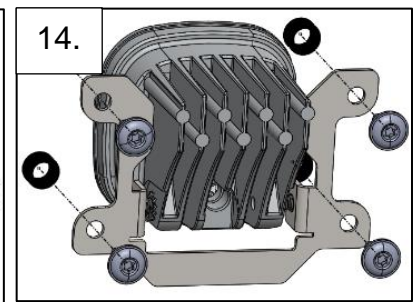

15. Plug in the squadron light to the piggyback adapter harness. Make sure the wire configuration is correct.

Pin A = Black Wire
Pin B = Brown Wire

16. Before install, adjust the light so the front is parallel with the flat surface on the bumper.

17. Using the 13mm socket, re-install the support bracket with the (2x) bolts.

18. Using the 10mm socket, re-install the splash guard with the (2x) bolts.

19. Repeat steps 8-18 for the opposite side light.

20. For bumper install, bring the bumper close to the vehicle, plug in the main connector.

21. Using the 21mm socket, re-install the (6x) bumper nuts. Ensure the bumper is centered on the vehicle before tightening.

22. Re-align the tow hook covers to fit properly around the bumper.

23. Remove any spring clips remaining in the steel bumper.

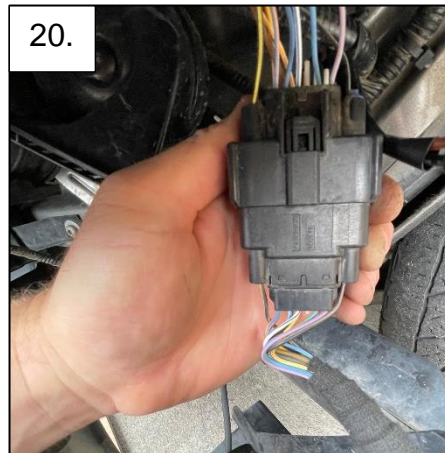
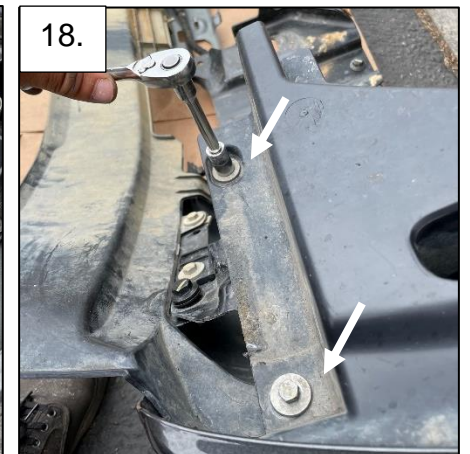

24. Bend the steel teeth back into the spring clip for ease in installation.

25. Place the clips back onto the plastic lower grill trim panel.

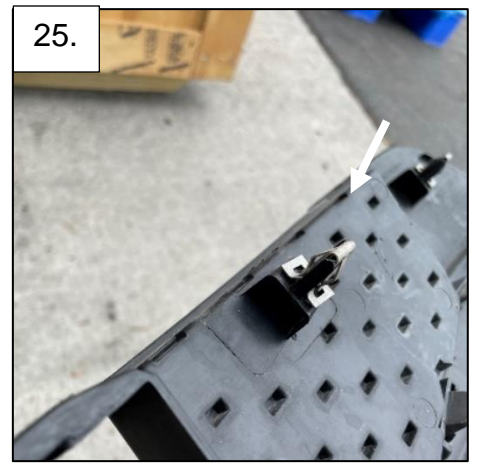
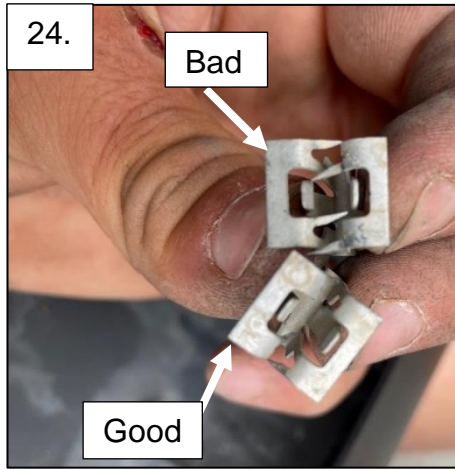

26. Plug in the parking sensors and clip the harness back to the plastic trim panel.

27. Place the (5x) plastic clips back into the topside of the lower grill opening.



28. Using the 10mm socket, re-mount the bottom side of the bumper with the (5x) bolts.

29. Using the 10mm socket, re-mount the license plate holder with the (2x) bolts.



Tie all wires away from sharp, hot, and/or rotating components.

Re-torque all the fasteners after 100 miles.

Your install is now complete! Thank you for choosing Baja Designs.

Ford Bronco 21+ Plastic Bumper Fog Pocket kit Instructions

Tools Required

- 4mm Allen Wrench
- Trim tool (preferred), or Flathead screwdriver
- 15mm and 10mm Sockets
- 1/2" wrench

1. To begin, place the vehicle in park, turn off and disconnect the negative battery terminal (1/2" wrench).
2. With the trim tool, pry on the right side of the passenger side plastic fog light fascia and in the other arrowed locations shown to remove. Disconnect the parking sensors (if equipped). Repeat for driver side.
3. With the 15mm socket, loosen the three circled bolts on the passenger side of the bumper and repeat for the driver side. With an assistant helping to lift the bumper, support the weight and remove the loosened bolts. Before removing the bumper, disconnect the main upstream bumper harness connector behind the driver side headlight.
4. Place bumper face down on a soft work surface.
5. Remove the OEM fog light harness connector. With the 10mm socket, remove the four circled mounting screws. Place OEM fog light aside. Repeat for opposite side. (Passenger side shown)
6. With the 4mm Allen wrench, mount the Squadron lights onto each provided bracket with the parts bag hardware as shown.
7. Place one Squadron fog light assembly onto the passenger side bumper fog mount and with the 10mm socket, tighten the four OEM screws. Use care to not strip the holes. Repeat for the driver side.
8. Pin the provided harness adapters as shown with the brown wire terminal in the connector pin location (B) and the black wire in (A). Plug the adapter into the Squadron and then into the OEM fog connector. Repeat for other side.
9. Install the bumper by following steps 4 through 2 in reverse.
10. Reconnect negative battery terminal.

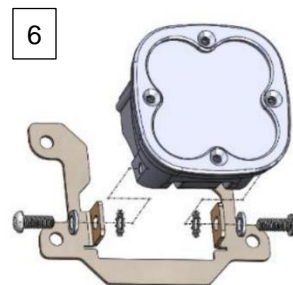

Tie all wires away from sharp, hot, and/or rotating components.

Re-torque all the fasteners after 100 miles.

Your install is now complete! Thank you for choosing Baja Designs.

Ford Bronco 21+ Capable Bumper Fog Pocket kit Instructions

Tools Required

- T25 Torx Bit
- 4mm Allen Wrench
- Trim tool (preferred), or Flathead screwdriver
- 8mm Socket
- 1/2" wrench

1. To begin, place the vehicle in park, turn off and disconnect the negative battery terminal (1/2" wrench).
2. Start by unmounting the plastic trim piece on the back of the OEM fog light on the passenger side. Use 8mm socket to unbolt the trim piece. Disconnect the parking sensors (if equipped) and plastic retaining clips. Repeat for driver side.
3. Remove the OEM fog light harness connector. With everything removed, the OEM fog light mounting bracket can be removed from the bumper.
4. Using a T25 Torx Bit, remove the (4x) bolts mounting the OEM fog light mounting bracket.
5. With the 4mm Allen wrench, mount the Squadron lights onto each provided bracket with the parts bag hardware as shown.
6. Pin the provided harness adapters as shown with the brown wire terminal in the connector pin location (B) and the black wire in (A). Connect the adapter provided in the kit bag to the OEM fog light harness connector.
7. Reinstall the squadron on the OEM fog light mounting bracket using the T25 Torx.
8. Install the fog light assembly back onto the bumper. Follow step 3.
9. Plug the adapter into the Squadron power cable to complete the connection.
10. Mount the rear trim piece by following step 2. Repeat for other side.
11. Reconnect negative battery terminal.

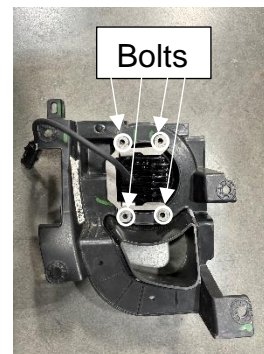
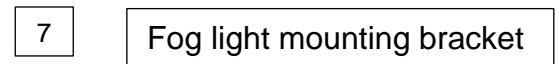
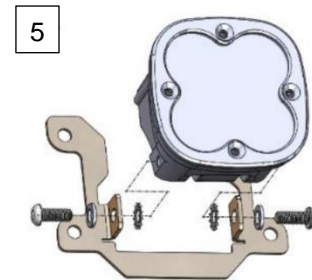
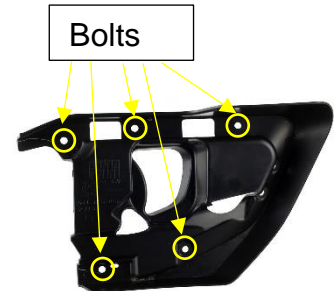



Tie all wires away from sharp, hot, and/or rotating components.

Re-torque all the fasteners after 100 miles.

Your install is now complete! Thank you for choosing Baja Designs.