



baja designs[®]
THE SCIENTISTS OF LIGHTING

2022 Toyota Tundra TRD Pro Grille Conversion Kit (44-8078, 44-8079)

OEM TRD Pro grill not included



2950 Norman Strasse • San Marcos • CA • 92069

Phone 760-560-2252 X3 • Fax 760-560-0383

info@bajadesigns.com • www.bajadesigns.com



baja designs[®]
THE SCIENTISTS OF LIGHTING

LIMITED LIFETIME WARRANTY

Baja Designs proudly offers a LIFETIME WARRANTY against manufacturer's defect on all the products that we manufacture.

These are comprehensive warranties; other than the exclusions below – you're covered. If your LED or HID bulb burns out, you're covered. Additionally, cutting off our connector or changing your lenses does not automatically void your warranty.

Exclusions:

Installation errors, abuse, misuse or crash damage. You must be the original owner of the product and can supply proof of purchase.

Baja Designs manufactures its own products as well as resells products manufactured by others. Baja Designs makes no express or implied warranties on products not manufactured by Baja Designs including without limitation any warranties or merchantability and fitness for a purpose. We will, however, pass on all warranties made by the manufacturer, who has sole responsibility for performing such warranties.

Baja Designs will pay the freight if your product is less than 90 days old, otherwise defective products must be returned to Baja Designs, Inc., freight prepaid. At our option, we will repair or replace items in question and return them at no charge. If the identical product is no longer available, we will replace with a similar product of equal value. Baja Designs Inc. will not be responsible for any indirect or consequential damages in connection with defective merchandise.

Items purchased through a Baja Designs authorized dealer must be returned through the dealer. Only available on LED auxiliary lights and product must be in sellable condition at MSRP. Product that has been damaged in any way after the original purchase date will be excluded from this guarantee.

Indemnification:

Buyer hereby acknowledges off-roading, racing and driving at night are dangerous activities and that the products and/or supplies purchased from Baja Designs are used in an inherently dangerous activity that may endanger life and limb; and in no event shall the seller, or seller's heirs and assigns, be held liable for consequential damages, nor shall seller's liability on any claim for damages arising out of or connected with the sale, delivery, or use of purchased products and/or supplies exceed the purchase price of the products and/or supplies.

Buyer is responsible for ensuring that it uses the products (and its vehicle) in accordance with all applicable laws, regulations, guidelines, and standards of care. Buyer acknowledges that some products may only be used when off-roading, and Buyer will comply with all vehicle and road safety guidelines. Buyer is solely responsible for (and will indemnify and hold Bestop harmless for) any claims, losses, damages, fines, fees, costs, or other amounts arising out of Buyer's non-compliance with these provisions.

Tools Required

- | | | |
|----------------------|----------------------------|---------------|
| * 10mm, 7/16" socket | *3/4" drill bit | *T25 Torx |
| * Trim removal tool | *Phillips head screwdriver | *7/16" wrench |

To begin, make sure the vehicle is in park, on level ground and the parking brake is engaged.

1. Using a 10mm socket, remove the 5 frontmost screws from the driver side inner wheel well to release the front edge of the fender flare. Carefully pull the front of the fender flare away from the fender until the clips release up to near the back of the headlight.

2. Repeat step 1 for the passenger side of the vehicle.

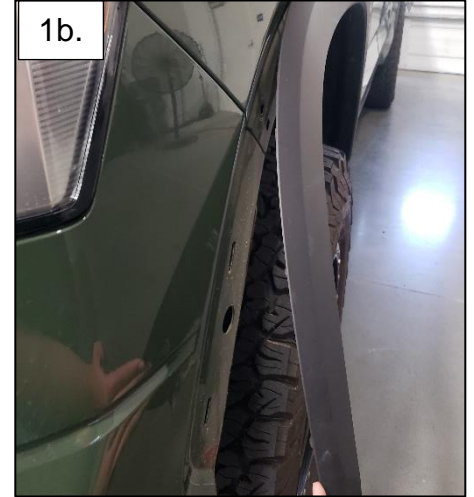

3. Using a 10mm socket, remove the 4 bolts securing the lower bumper assembly.

4. Using a 10mm socket, remove the 4 bolts securing the upper grill.

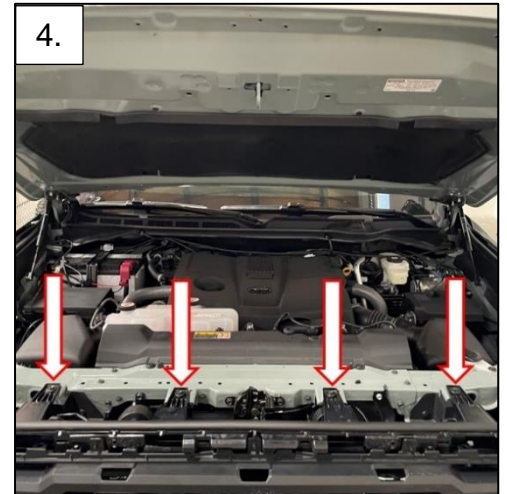
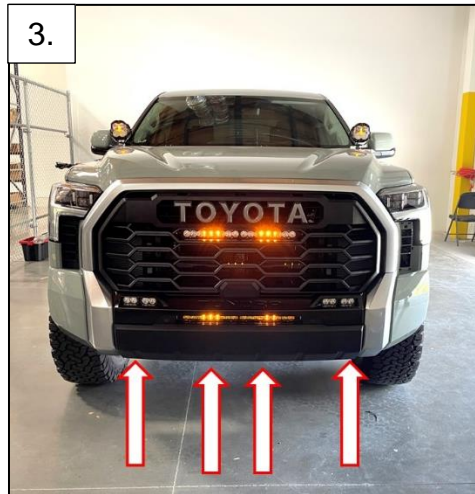

5. Remove the electrical connectors from the top of the grill near the top of the radiator. For TRD models, there are two on the driver side and two on the passenger side. For non-TRD models, there are two on the passenger side and one on the driver side.

6. Using a trim tool or flathead screwdriver, remove the 2 plastic push rivets from either side of the grill near the previously disconnected electrical connectors.



7. Starting from inside the driver side fender well, carefully pull the front clip sideways and forward to release all the clips under the headlight and grill vent. Repeat for the passenger side.

8. With the help of an assistant, carefully remove the front clip of the vehicle by pulling forward and set it on a soft work surface. There are three clamping features (boxed) that will release with a light forward tug and an audible click.

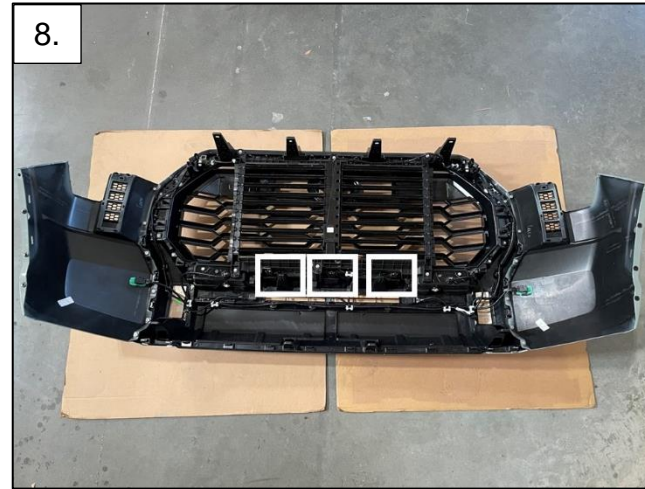

9. Locate the included wiring harness and mount the relay using the tab on the relay to the common ground located next to the passenger side air box.

10. Locate the light connector lead of the wiring harness and starting at the battery, route it towards the radiator.

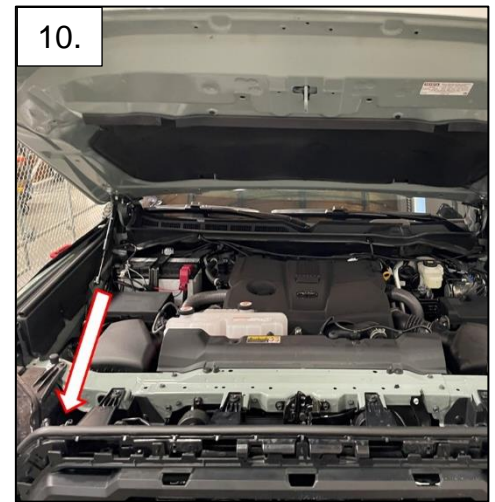
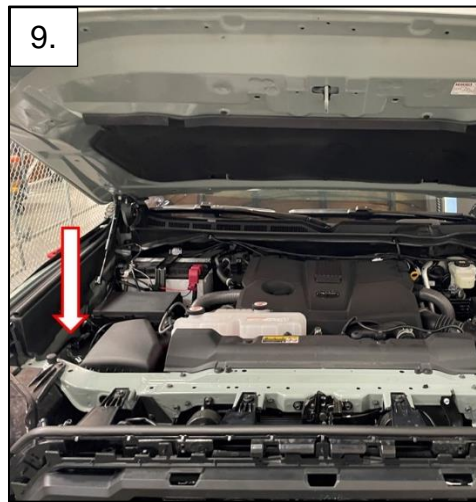

11. Run the switch lead along the firewall and to the wiring passthrough located to the right of the brake master cylinder.

12. Select a location on the dash for the switch. A suggested location is outlined in photo 12a. Check for clearance behind the panel and drill a 3/4" hole for the switch. To access behind this panel, remove the dash endcap by carefully prying from the bottom of the panel as illustrated in photo 12b.

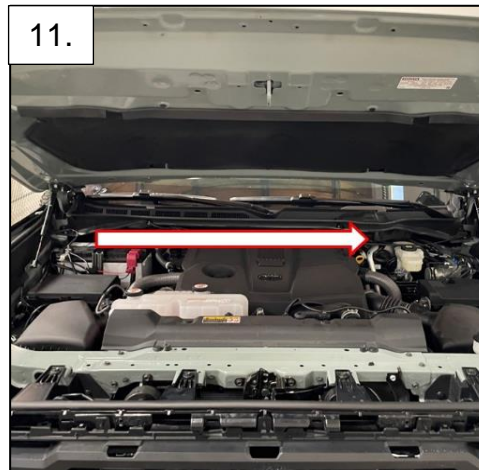

13. Take a reference photo of the switch wiring. Disconnect the spade connectors and run the wires through the firewall and switch hole. Plug the switch back in and install it into the hole.

14. Open the passenger side fuse box located near the air cleaner. Find the ignition pin shown in photo 14.

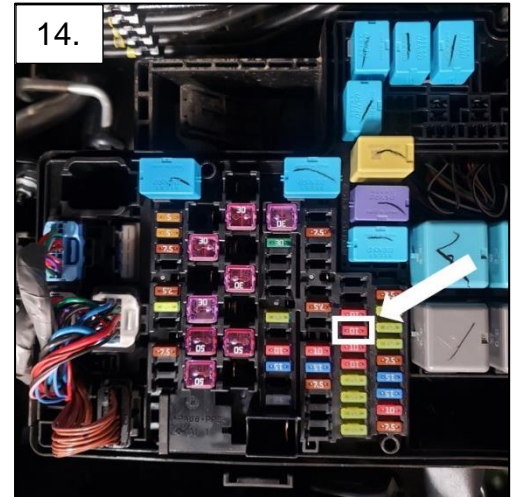
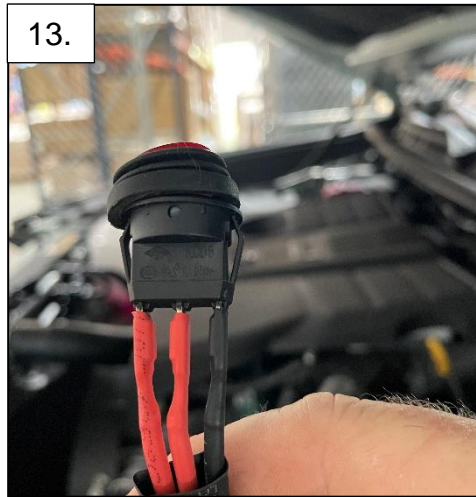

15. Remove the 10-amp fuse and insert the fuse tap from the backlit add-on kit into the fuse slot. Insert the 10-amp fuse in the open slot in the fuse tap. Run the fuse tap wire out of the bottom of the fuse box and replace the cover.

16. Plug the backlit wire into the fuse tap and run it along the firewall, around the passenger side air box and to the light connector of the main harness. Open the main harness connector lock and insert the wire into slot C (shown in 16b). Make sure the wire terminal clicks into place and close the connector lock.

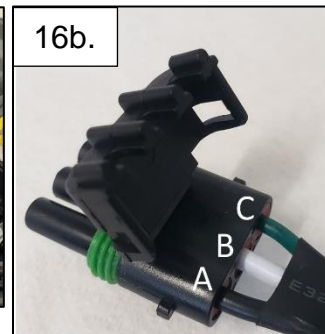
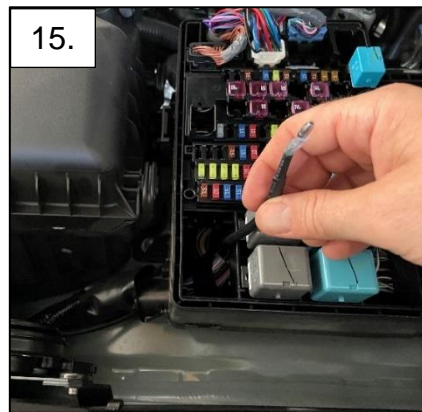

17. Using a 10mm socket, remove the 6 bolts (arrowed) holding in the shutter assembly and disconnect the shutter assembly connector (circled) at the top of the grill.

18. Disconnect the driver side parking sensor (circled) and remove the 6 Phillip head screws (arrowed) holding on the bumper cap and remove the cap. Repeat for the passenger side.

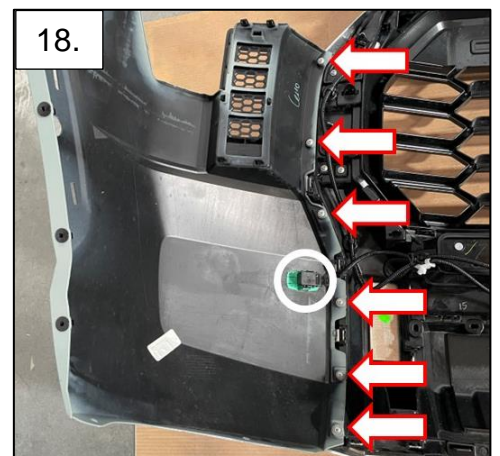
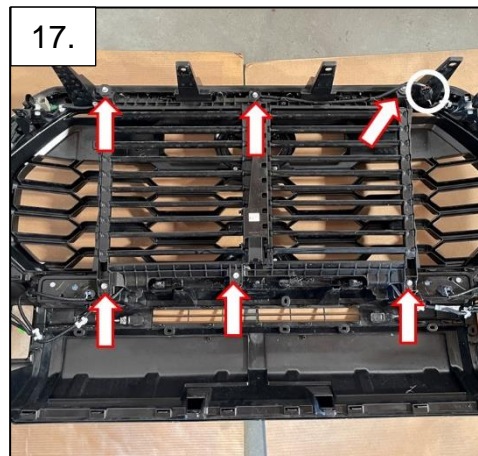

19. Unplug the TSS module located at the bottom of the grill. Remove the three screws (arrowed) holding it in using a Phillips head screwdriver. Remove the module and the TSS cover from the grill.

20. Unplug the front facing camera and with a Phillips head screwdriver, remove the screws (arrowed) holding it in. Remove the camera.

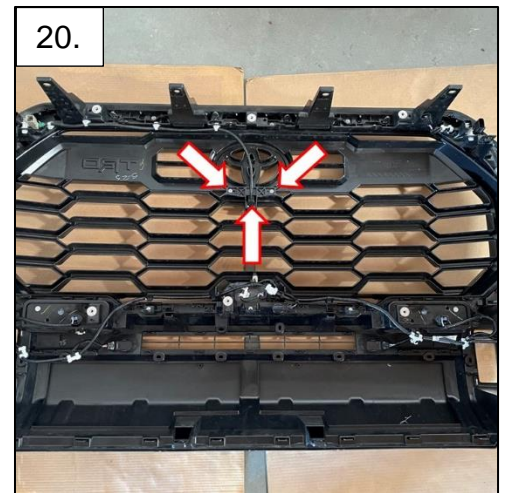
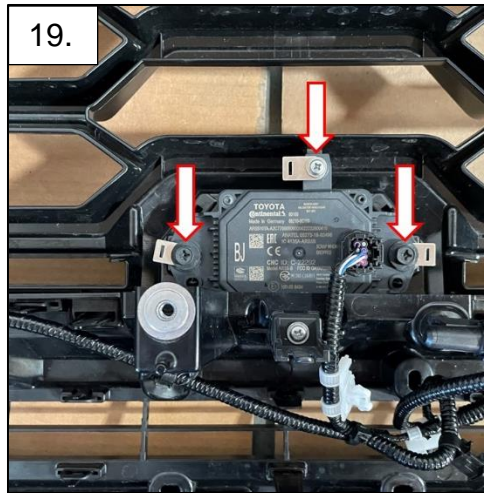

21. Remove the 6 Phillips head bolts along the top edge of the grill (circled). Remove the 5 Phillips head bolts (arrowed) on the driver side of the grill and repeat for the passenger side.

22. Using a trim removal tool, unclip the upper grill bezel from the grill and remove the bezel.

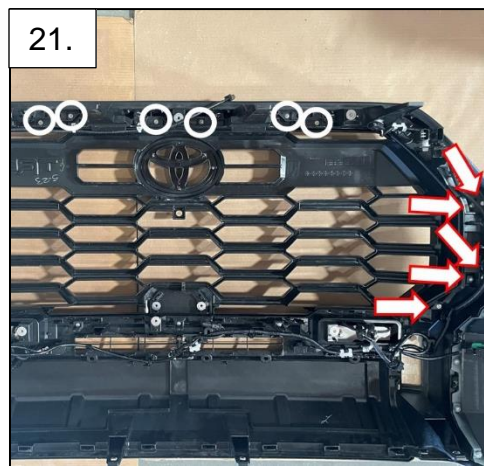

23. Locate and, using a trim tool, unclip the tabs securing the grill to the front clip.

24. Remove the driver side lower grill bezel by releasing the 7 tabs. Repeat on the passenger side.

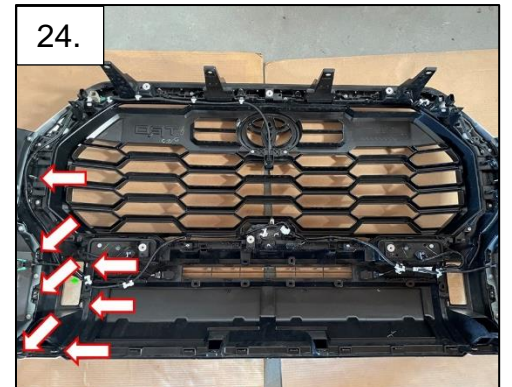
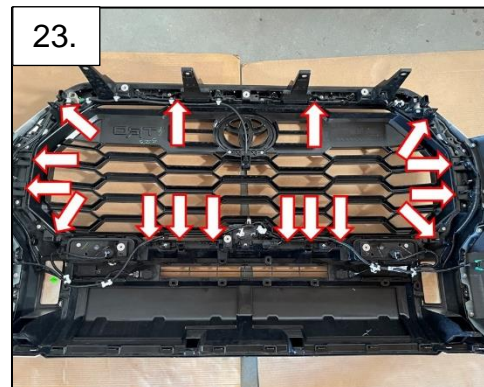

25. With the help of an assistant, flip the grill over and remove the upper bumper cover and the stock grill.

26. Insert the TSS cover into the TRD Pro grill and place the grill into the grill structure. Make sure all the tabs snap into place. Reinstall the upper bumper cover.

25.

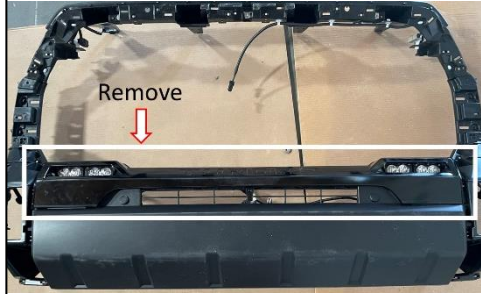

26.



27. Flip the grill to be face down and install the front facing camera into the grill using the included Phillips head screw and hold down tab.

28. Place the 8mm hex head bolt through the rubber base with the head of the bolt recessed into the base and secure it with a nut. Add the second nut and place the assembly onto the vehicle specific bracket. Add the last nut to sandwich the bracket between the two nuts. The rubber base should face away from the light mounting tabs.

27.



28.

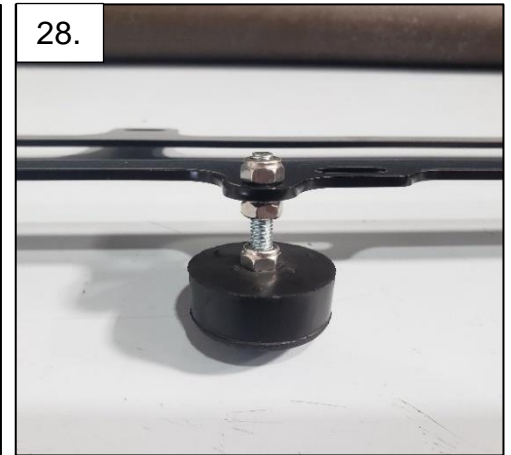

29. Using a 7/16" wrench and the included parts bag, install the S8 into the vehicle specific light bracket. The light should face away from the rubber base.

30. Using a T25 Torx, Phillips head screwdriver and the included hardware, install the light, bracket and support braces following photos 30a & b. For best performance, the light should be centered and level or angled 1° down.

29.

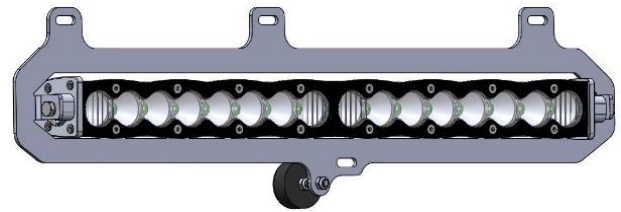

30a.

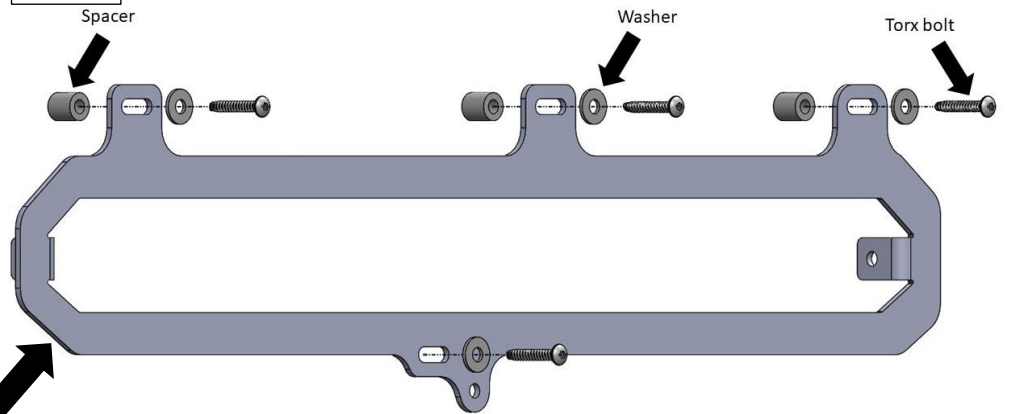

Light bracket

31. Remove the 2 white clips closest to the forward-facing camera (circled) holding the camera wire in place and plug in the camera. Zip-tie the camera wire to the light bracket to secure it.

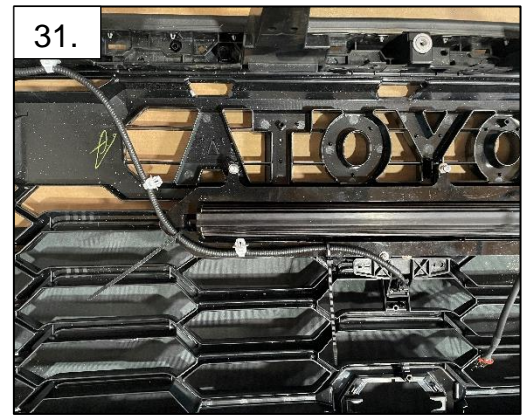
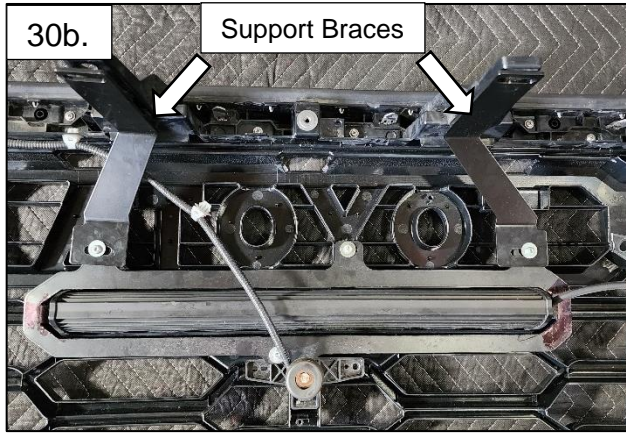

32. With a Phillips head screwdriver, reinstall the driver and passenger side bumper caps and reinstall the parking sensor.

33. Reinstall the TSS module using the 3 earlier removed Phillips head bolts.

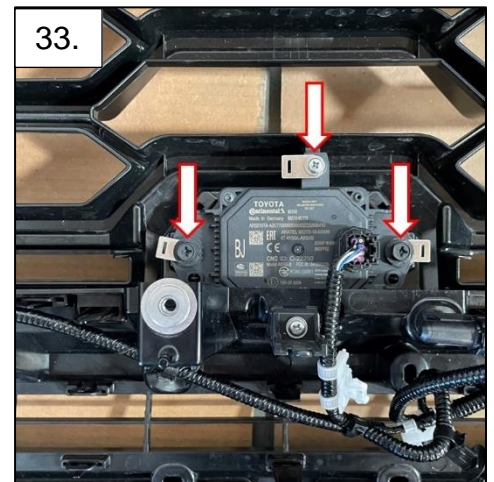
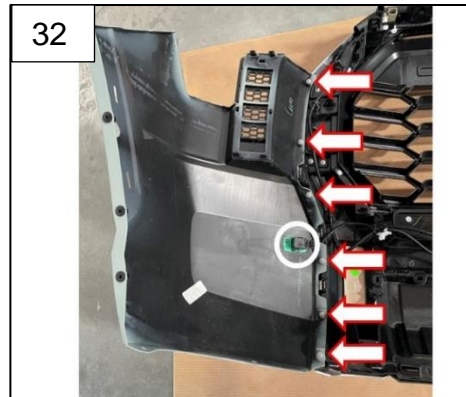

34. Reinstall the lower grill bezels and secure with the 5 removed Phillips head bolts on either side (arrowed). Reinstall the upper grill bezel and secure with the 6 removed Phillips head bolts (circled).

35. Using a 10mm socket, reinstall the shutter assembly using the 6 removed bolts (arrowed) and connect the shutter assembly harness (circled). Route the S8 power cord up to the upper passenger side of the grill towards the other wire connectors.

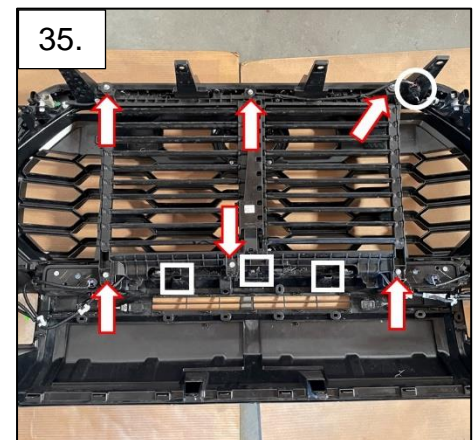
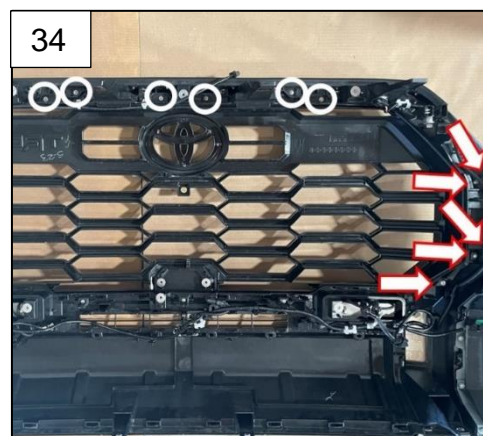

37. Using a 12mm wrench, remove the negative battery cable. Install the positive (red) ring terminal of the wiring harness to the positive wire of the battery. Install the negative (black) ring terminal of the harness to the negative battery cable and reattach the negative cable to the battery. Plug the S8 into the wiring harness and test the light.

36. With an assistant place the front grill assembly onto the vehicle ensuring the 3 tabs (boxed in photo 35) clip into place and secure using the two plastic push rivets.

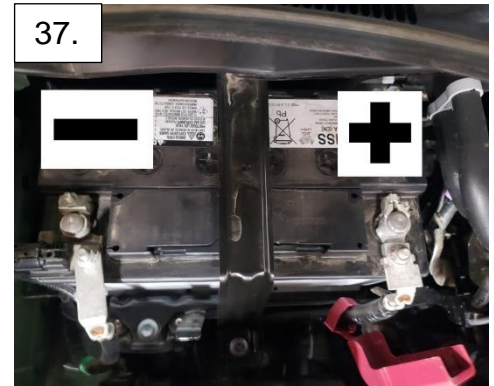

For Hybrid vehicles only

H1. Remove the passenger side fuse panel cover and locate the positive battery wire and post (boxed).

H2. Using a 12mm socket, remove the nut holding down the wire and release the tab to the right of the post. Lift to remove the wire and plastic wire cover.

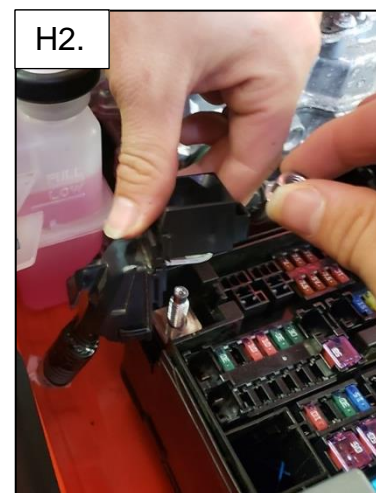

H3. Twist to pull apart the top of the plastic cable cover until it resembles photo H3. Using a flat head screwdriver, release the 2 tabs on the bottom of the plastic wire cover until the two halves separate and remove them from the wire. Discard the piece that the wire terminal runs through.

H4. Replace the battery cable and install the positive (red) ring terminal of the main wiring harness onto the post. Replace the upper battery cable cover and reinstall the 12mm nut and replace the fuse box cover.

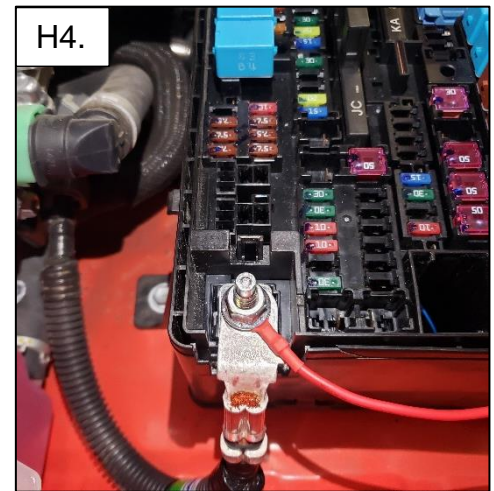

H5. Using a 10mm socket, remove the common ground bolt that the main harness relay is secured to and install the negative (black) ring terminal. Replace the ground bolt. Plug the S8 into the wiring harness and test the light.



38. Snap in the driver side outer fenders starting under the headlight and moving outwards. Repeat on the passenger side of the vehicle.

39. Reinstall the driver side fender flare and secure using the 5 removed 10mm bolts. Repeat on the passenger side of the vehicle.

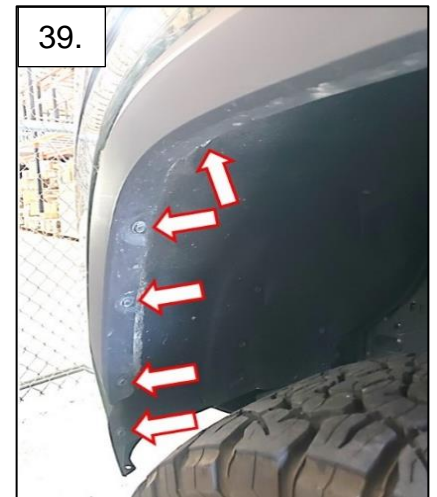

41. Reinstall the 4 bolts securing the top of the grill to the core support ensuring to sandwich the support braces between the grill and core support. Reinstall the 4x 10mm bolts securing the bottom of the bumper to the core support.

42. Reconnect the OEM plugs on the driver and passenger side of the grill.

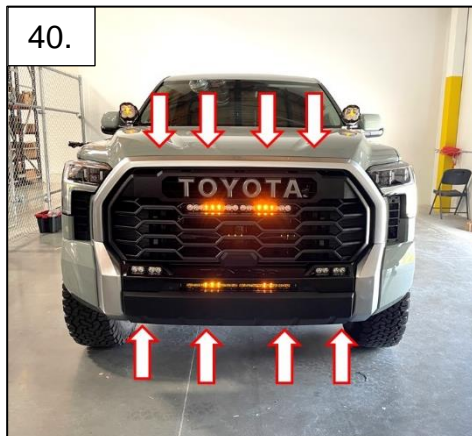

*Tie all wires away from sharp, hot, and/or rotating components.

* Re-torque all the fasteners after 100 miles.

*Your install is now complete! Thank you for choosing Baja Designs.