

ARB TOYOTA 200 SERIES REAR STEP TOW BAR

Product number: 5615010 / 5615040



**READ FITTING INSTRUCTIONS
CAREFULLY BEFORE PROCEEDING**

USE	PART No	QTY	DESCRIPTION
FIT TAIL LIGHT ASSEMBLIES TO REAR BAR	6821172L	1	Tail Light Assembly – Left Hand Side (LHS)
	6821172R	1	Tail Light Assembly – RHS
	6151017	12	Bolt M6 x 16
	6151128	8	Nut M6 flange
	6151300	4	Nut M6 cage
	6151046	12	Washer 6mm flat
	3756681	2	Light mount cover bracket
FIT CAGE NUTS TO REAR BAR	6151300	17	Nut M6 cage
	6151303	4	Nut M8 cage
FIT LOCKING PIN BRACKETS TO REAR BAR	3756701	2	Locking pin bracket
	6151022	4	Bolt M8 x 25
	6151132	4	Nut M8 flange
	4581044	4	Washer 8mm flat
FIT LOOM TO VEHICLE	6821209	1	Loom
	180302	6	Cable tie
CHASSIS CAGE NUT PLATES	3194024	4	Chassis cage nut plate
	6151305	4	Nut M12 cage
FIT BAR TO REAR CROSS MEMBER	6151340	4	Bolt M12 x 50 x 1.75
	4581049	4	Washer 12mm flat
	4581050	4	Washer 12mm spring
	3757724	1	Plug relocating bracket
	6151300	2	Nut M6 cage
	6151017	2	Bolt M6 x 16
	6151046	2	Washer M6 flat
FIT BAR TO UNDERSIDE OF CHASSIS	3194020	2	Packer chassis 8mm
FIT CENTRE COVER PANEL(S)	6522711	1	Centre cover panel
	6522715	1	Receiver cover panel
	6522716	1	Pintle cover panel
	3757684	1	Cover mount
	6151256	2	M6 button head cap screw stainless
	6151017	4	Bolt M6 x 15
	6151046	6	Washer 6mm flat
	4581036	4	Washer 6mm spring
	6151300	2	Nut M6 cage
FIT END SURROUNDS TO REAR BAR	3131304L	1	End surround LHS
	3131304R	1	End surround RHS
	6151083	2	Bolt M8 x 35
	6191022	2	Side moulding 700mm
	6151022	4	Bolt M8 x 25
	6151132	2	Nut M8 flange
	4581046	6	Washer M8 spring
	4581044	6	Washer 8mm flat
	6250003	6	Spacer 8mm thick gold zinc

FIT END SURROUND BRACKETS	3757680L	1	End surround bracket LHS
	3757680R	1	End surround bracket RHS
	6151357	8	Bolt M10 SEMS
	6151321	8	Nut M10 flange
FIT FOG/REFLECTOR MOUNTS	3162478L&R	2	Vertical trim
	3163024L&R	2	Fog/Reflector mould
	3757780L&R	2	Mould mount
	6821208	2	Reflector
	665001	1	Rib tape 1meter
	6151022	4	Bolt M8 x 25
	4581044	4	Washer M8 flat
	4581046	4	Washer M8 spring
	6151303	4	Nut M8 cage
	6151384	6	Screw self tapping
6151176	4	Screw self tapping (for fog light kit)	
FIT OPTIONAL MUDFLAPS	3194013	2	Mudflap mount plate
	6151228	10	Bolt M6 x 30 black
	6151300	10	Nut M6 cage
	4581082	10	Washer 6mm flat black
FIT TOP INFILL PLATE	3199726	1	Top infill plate
	3199727	1	Aluminium step plate
	4590019	1	Rubber extrusion seal
	6151256	9	Button head cap screw M6 x 16 stainless steel
FIT GOOSENECK	4761171	1	Gooseneck Assy 200 Series
	55010	1	Pull pin
	55020	1	Spring Clip
FIT TRAILER PLUG	6151370	2	Screw M5 plastite pan head

PARTS SUPPLIED WITH THIS KIT FOR USE WITH WHEEL/ JERRY CAN HOLDERS

FITTING NUMBER PLATE LIGHT	86060BL	1	Number plate light
	6151281	2	Screw M5 pan head
	6151282	2	Nut M5 flange
FIT CENTRE LOCATOR	3757690R	1	Centre locator bracket RH
	3757690L	1	Centre locator bracket LH
	6151022	6	Bolt M8 x 25
	4581046	4	Washer M8 spring
	4581044	8	Washer M8 flat
	6151132	4	Nut M8 flange
	6151212	2	Nut M8 nyloc

TOOLS REQUIRED: Basic tool kit, Torque wrench – 9-80Nm capacity, 30mm socket, ¼” drive socket set, silicon, air hacksaw or small grinder.

TORQUE SETTINGS: 6mm – 9Nm, 8mm – 22Nm, 10mm – 44Nm, 12mm – 77Nm

FITTING TAIL LIGHTS TO BAR

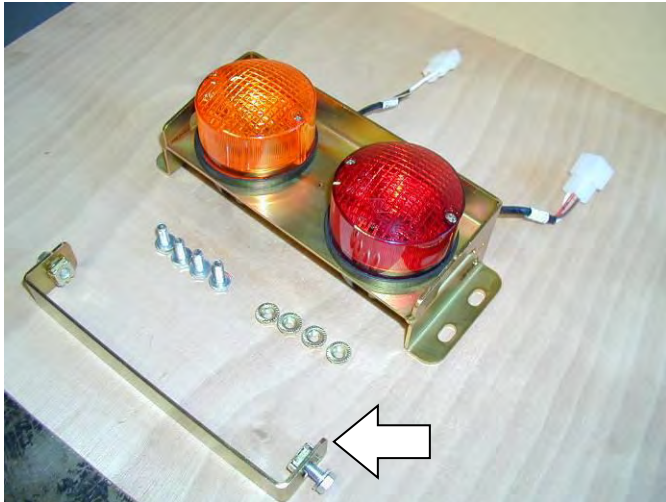

1. Compile components as shown.
 - Light assembly (LHS shown)
 - Light cover
 - 6 x M6 x 16mm bolts
 - 4 x M6 flange nuts
 - 2x M6 cage nuts
 - 6 washers to suit M6
2. Fit cage nuts to light cover as shown.

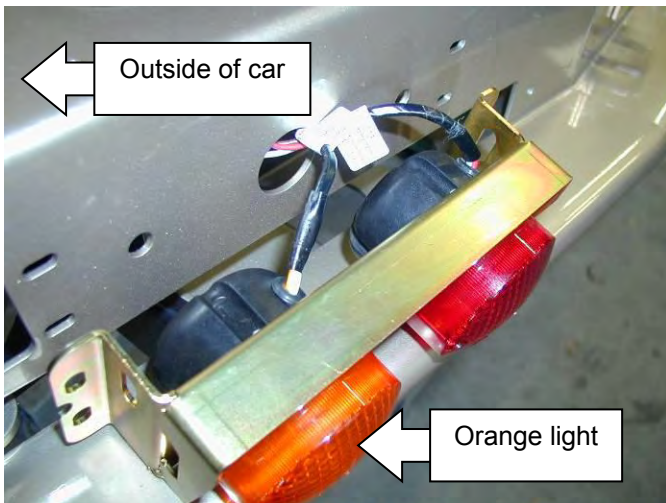

When fitting light assemblies to bar, orange (indicator) lights must be to the outside as shown. The flange on the bracket should also be at the top.

3. Feed looms through large hole in bar.



4. Fit light assemblies using M6 hardware. Finger tighten only.
5. Repeat steps 1 to 3 for RHS assembly.



6. Fit M6 cage nuts to light mount cover bracket as shown below.
7. Using **M6 x 16 bolts** and flat washers, fit cover bracket to light mount.

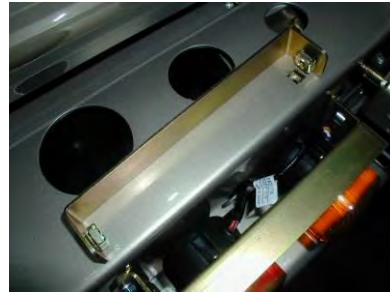

FITTING CAGE NUTS TO BAR



8. Fit M6 cage nuts (9 total) in square holes in top of bar as shown.

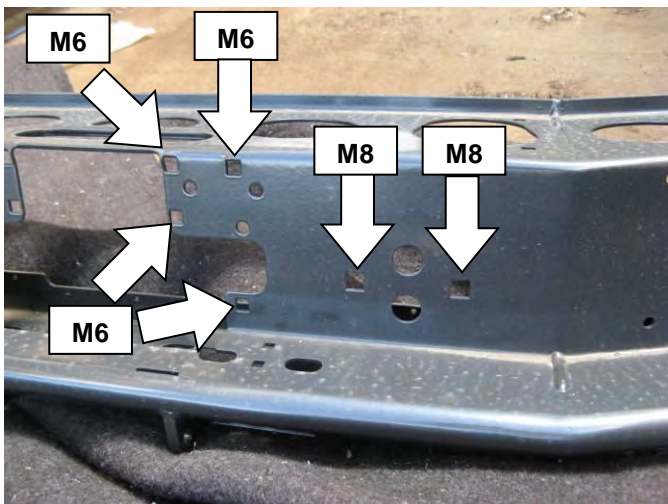

9. Fit M6 cage nuts (8 total) and M8 cage nuts (4 total) to front of bar. (RHS shown)

FITTING LOCKING PIN BRACKETS TO BAR

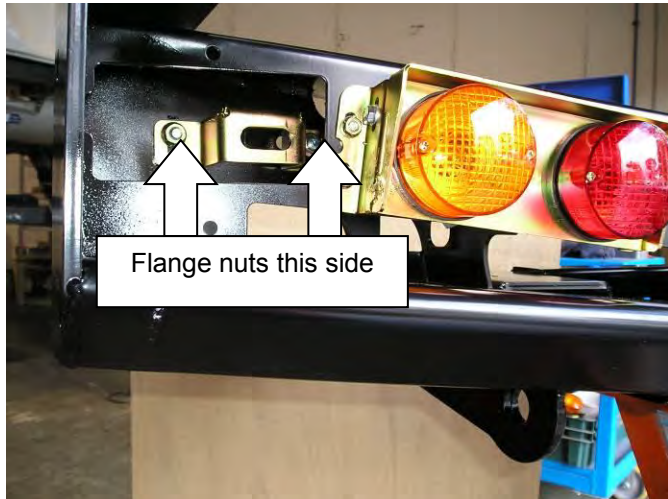

10. Fit locking pin brackets using two **M8 x 25 bolts**, flat washers and flange nuts. Finger tighten only.

Fit bolts through from rear of rear bar so that the flange nuts are on the same side as the bracket as the photo shows.

(Viewed from front of bar LHS.)

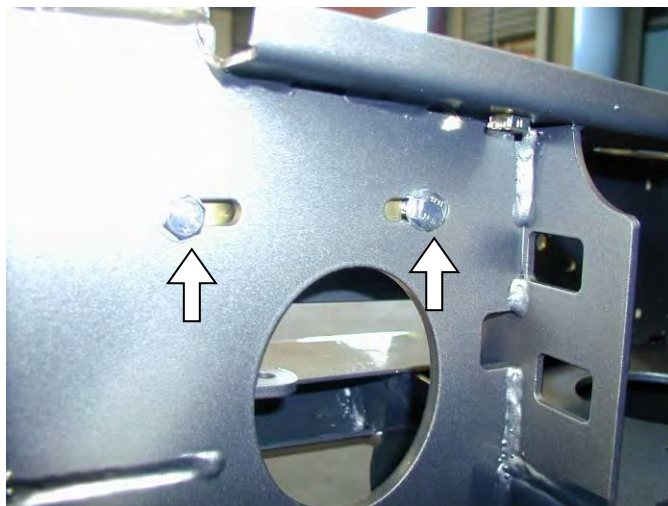

M8 bolts must fit in rear of bar for ease of adjustment later on.

(Viewed from rear of bar LHS.)



11. If a wheel carrier or jerry can carrier is not to be fitted a cover panel must be fitted.

If cover panels are to be fitted they must be fitted to the bar before it is fitted to the vehicle.

Refer to fitting instructions supplied in cover panel fitting kit for fitment of cover panel.

FITTING REAR BAR TO VEHICLE



12. To fit Rear Bar to vehicle, remove bumper bar, tie down points and mudflaps. Retain tie down bolts for later use.
13. Mask and paint lower panels as shown.

AT THIS STAGE FIT WIRING LOOM KIT 6821209. REFER LAST PAGES FOR INSTRUCTIONS.

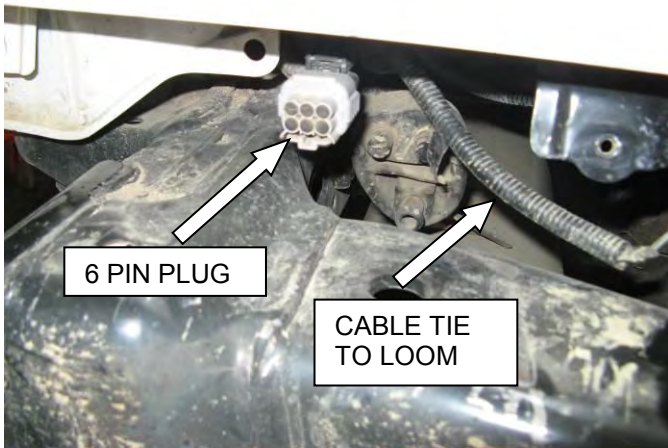

14. Locate and un-clip the 6 pin plug on the left hand side of the vehicle. Using cable ties supplied in kit attach it to loom that runs next to it making sure everything is clear of the exhaust.

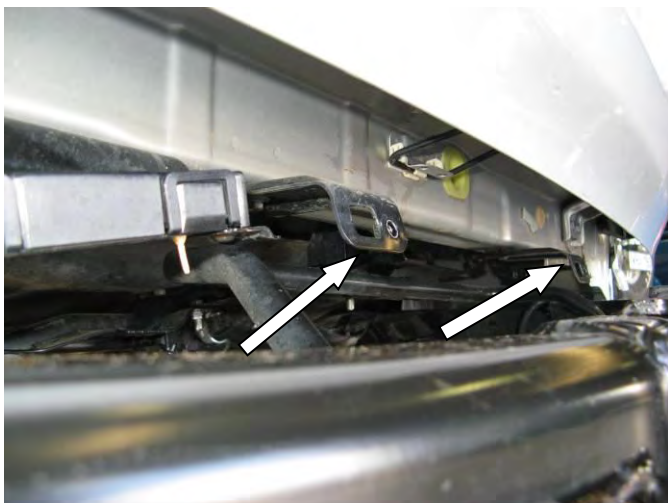

15. Remove bumper mounting brackets and discard.

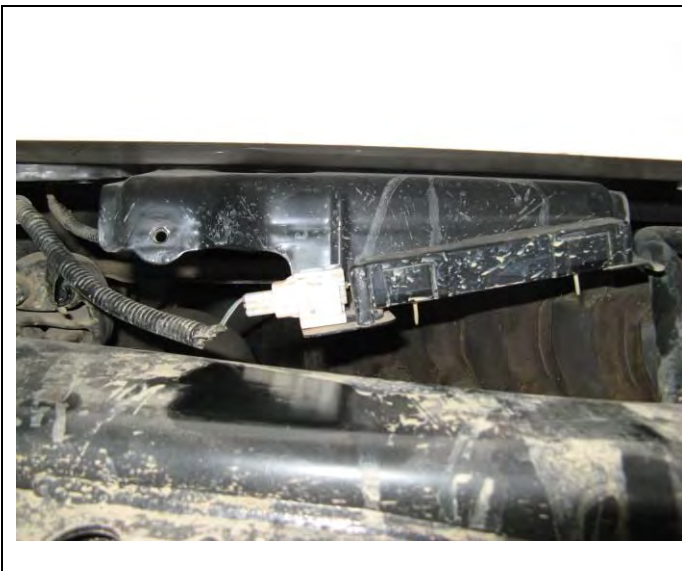

16. Locate steel bracket with plug attached on the left hand side of the vehicle. Un-bolt bracket from vehicle and retain hardware for next step.

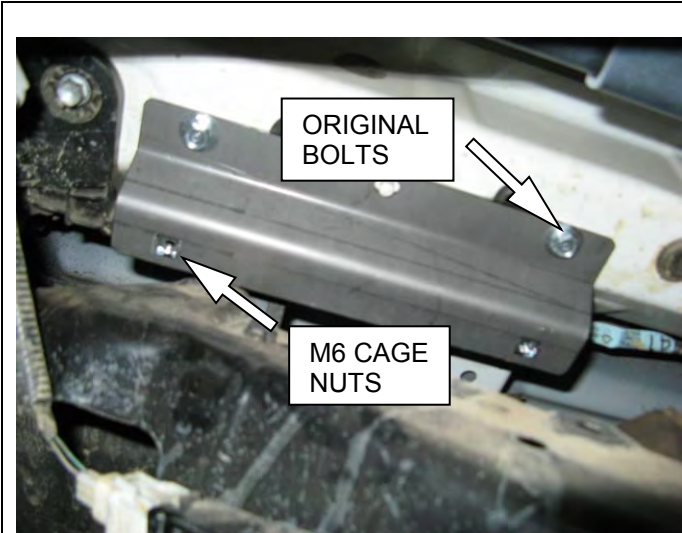

17. Attach two M6 cage nuts to new bracket supplied in kit. Fit bracket to vehicle using original bolts removed in step 16. Attach loom bracket to cage nuts using 2 x M6 x 16 bolts and flat washers.

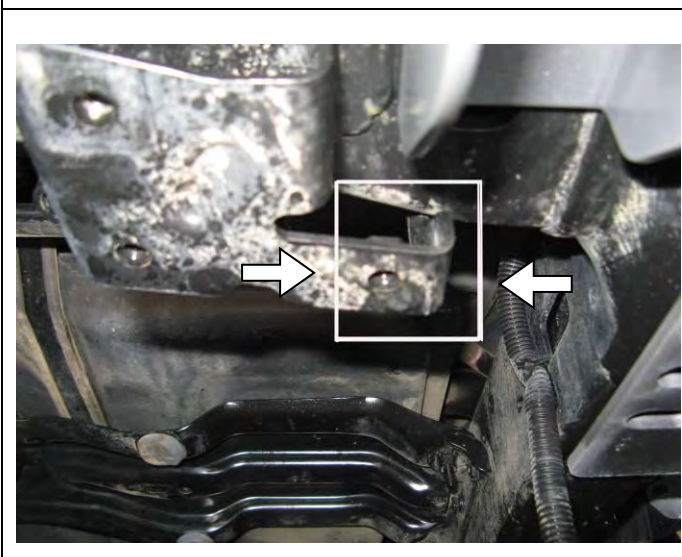

18. Locate right hand bumper bracket on underside of rear cross member. Area inside white box is to be trimmed to make way for rear bar mounts.



19. Trim bracket leg as shown using a small grinder with cutting disc or an air-hacksaw. Paint all bare metal surfaces after cutting.

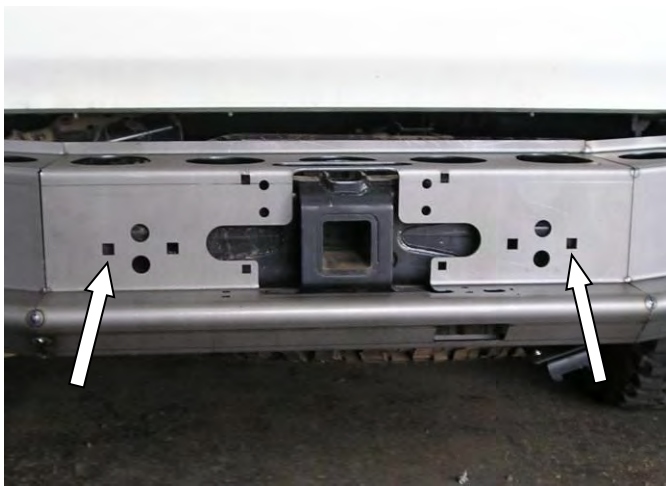

20. Place rear bar onto vehicle and using original tie-down bolts attach to chassis. Finger tighten only.

NOTE: Steps 21, 22 and 23 applies to pre 2013 vehicles as post 2013 vehicles do not have cross member.

21. Using a white marking pen mark two of the four mounting holes for the locking pin brackets on vehicle chassis. **Shown with arrows.**

22. Remove bar from vehicle.



23. Drill the marked holes out using a 22mm hole saw. Clean up all burrs and paint.

NOTE: These brackets may vary from vehicle to vehicle and the hole positions may vary, post 2013 vehicles may not have cross member.

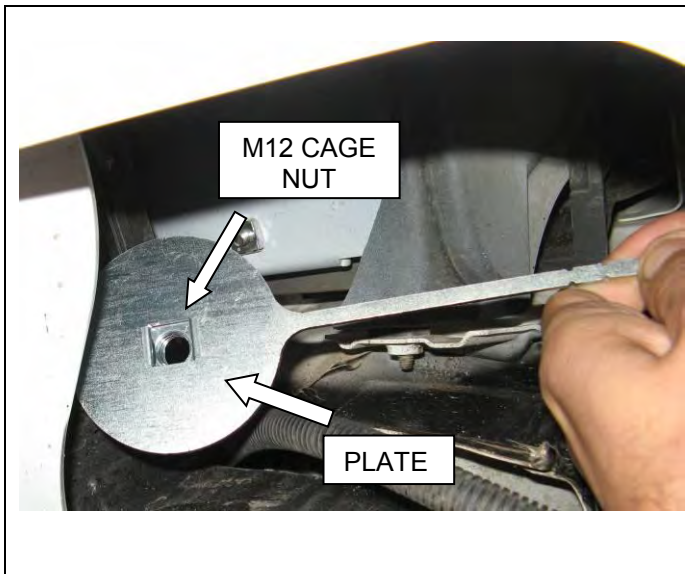

24. Fit M12 cage nut onto cage nut plates and insert through hole in side of chassis. Place one facing up and one facing down on each side. These are used to secure top and bottom inner mounts. **MUST BE INSTALLED BEFORE BAR IS MOUNTED.**

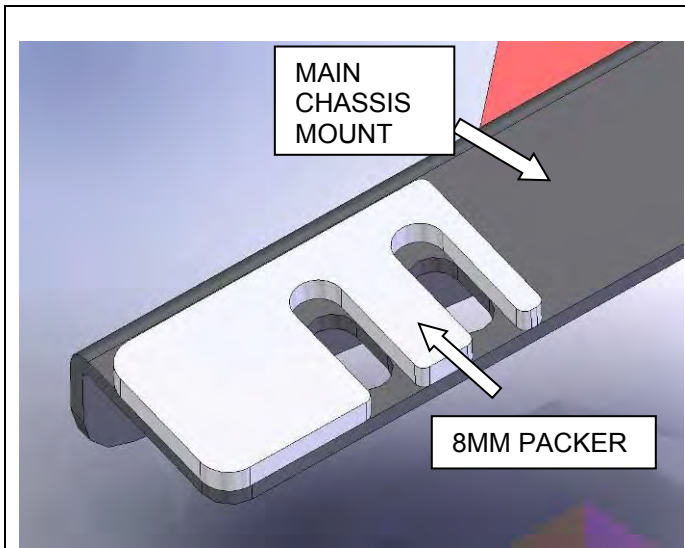

25. Place bar back on vehicle making sure there is enough clearance from step 23. When satisfied place the 8mm chassis packers on top surface of chassis mount and finger tighten only.



26. Secure bar to top of chassis and cage nut plates using 2 x M12 X 1.75 X 50 bolts, flat washers and spring washers.



27. Secure bar to bottom of chassis and cage nut plates using 2 x M12 X 1.75 X 50 bolts, flat washers and spring washers. **Tighten all bolts when done.**



28. This bar is designed to make use of 100 SERIES carriers. Because of the different tow bar arrangement of the 200 SERIES new locating brackets have been supplied. If carriers are to be fitted install these now as shown for relevant sides. LHS shown. If carriers are not to be fitted keep these items for future use.

AT THIS STAGE JERRY CAN CARRIERS OR WHEEL CARRIERS MUST BE FITTED.

TO FIT JERRY CAN CARRIERS AND WHEEL CARRIERS, REFER TO FITTING INSTRUCTIONS SUPPLIED IN FITTING KITS WITH JERRY CAN CARRIERS OR WHEEL CARRIERS.

IF A JERRY CAN CARRIER OR WHEEL CARRIER IS NOT TO BE FITTED, THE COVER PANEL SHOULD BE ALREADY FITTED. (REFER TO STEP 14.)

FITTING END SURROUNDS TO REAR BAR

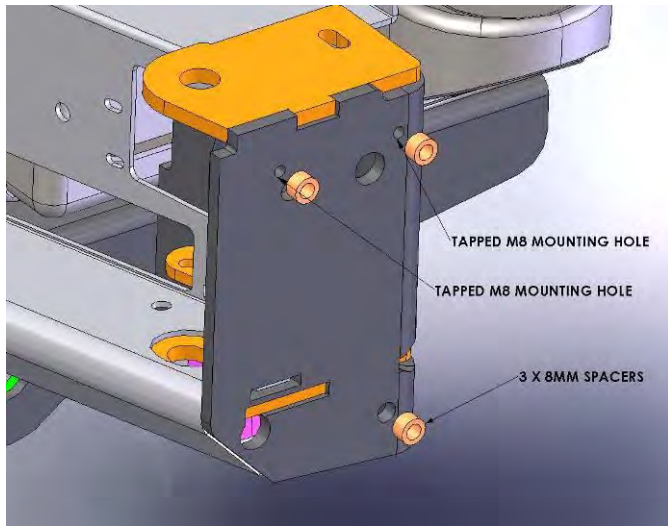

29. The uprights of the bar feature 2 tapped holes for an M8 thread, the bottom hole being open.

30. Attach the surrounds using 2 x M8 x 25 bolts, flat washers, spring washers, and 8mm spacers for the upper two holes. For the bottom hole use 1 x M8 x 35 bolt, flat washer, spring washer, 8mm spacer, and M8 flange nut. The assistance of another person may help when securing the surrounds. Finger tighten only.



31. Using two M10 SEMS bolts and M10 flange nuts attach surround brace to chassis as shown. LHS shown finger tighten only.



32. Using two M10 SEMS bolts and flange nuts attach surround brace to surround as shown. LHS shown finger tighten only.

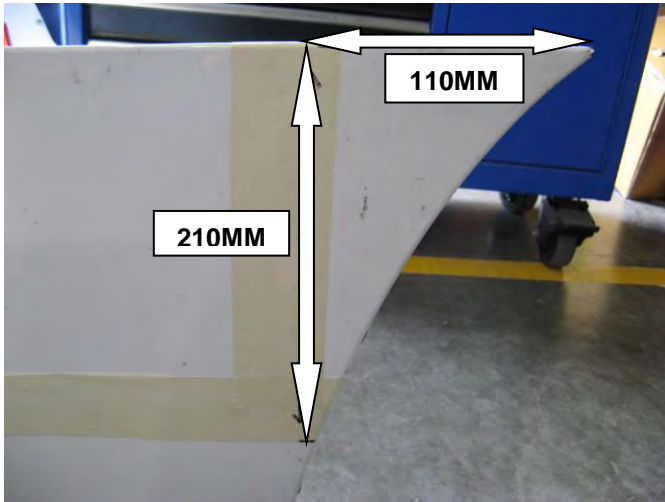

33. Remove fog light/ reflectors from rear bar. From top edge of wheel arch section measure back 110mm, then down 210mm. Mark this position.

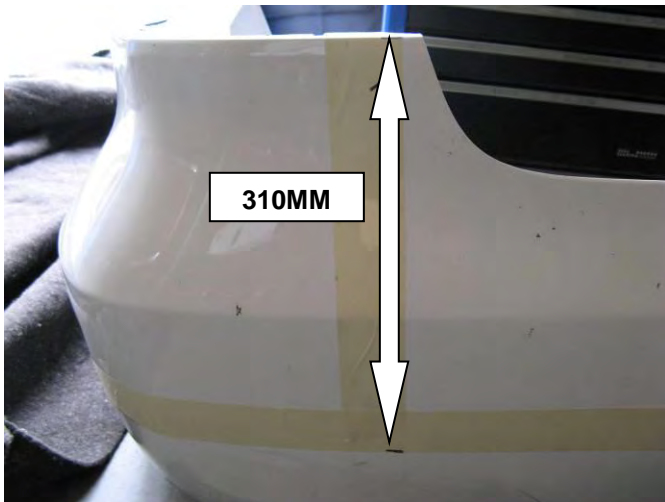

34. From edge of taillight section measure down 310mm and mark this point. Then using a length of masking tape join these points to form a straight line up to the recess for the fog light/ reflector.



35. Measure 120mm down from mould edge in bumper to side of fog light/ reflector. Mark this point. Then using a length of masking tape join these points to form a straight line up to the recess for the fog light/ reflector. **NOTE: Confirm line is straight by sighting down the length of bumper. If not re-adjust tape so a straight line is achieved.**

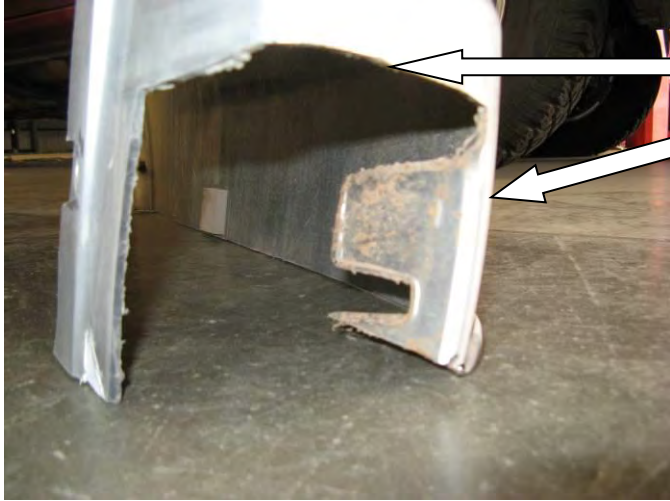

- 36. Procedure for fog light cut.
- 37. Mark along top edge of fog light radius continuing on inside edge towards tailgate.
- 38. Leave outer return edge of fog light mount intact only removing the bosses.

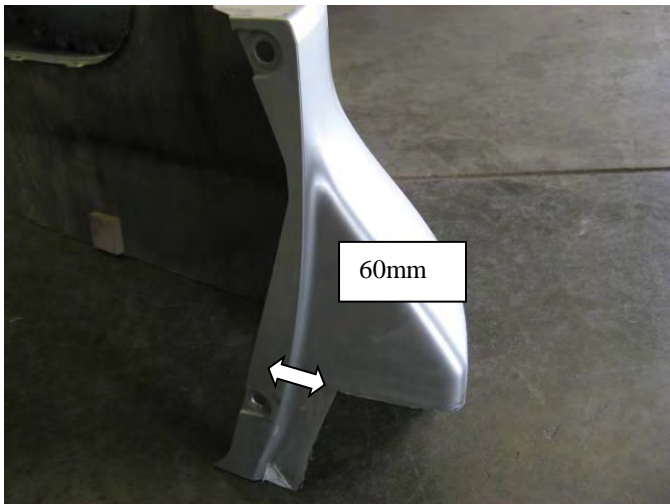

- 39. Tailgate side of bumper. Mark a line parallel to edge of rear face and inboard 60mm of bar up to previous marked line. Once all is marked cut using air hacksaw or similar and de-burr edges.



- 39. De-burr all surfaces when done. Access to a finishing machine will provide a nicer finish. Attach bumper section back on vehicle.
- 40. Fit rib tape along the bottom cut edges of the bumper.

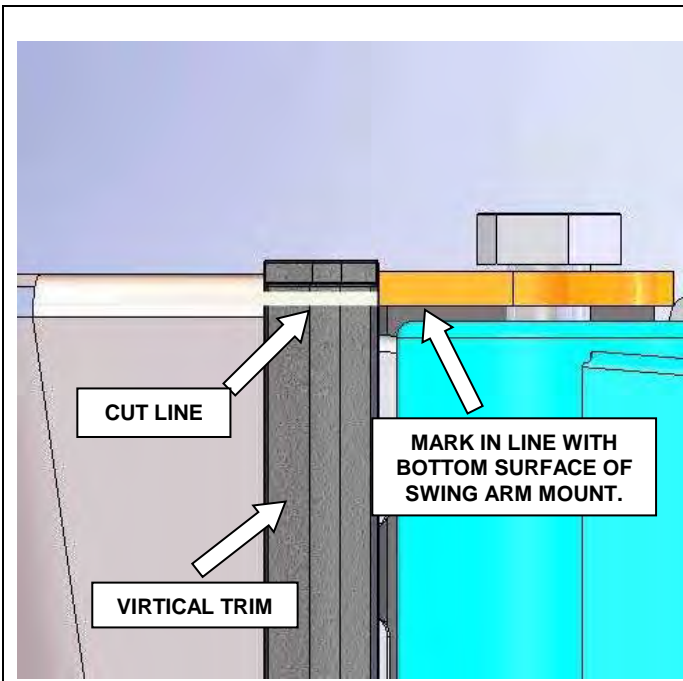

41. Before tightening wing bolts fit urethane vertical trim between end plate and end surround. Mark a point on trim as shown in photo (below middle) through access hole in wing. Mark a line as shown in the left photo. Once this is done cut top section and drill a 14mm hole in bottom point. This is to gain access to adjuster bolt. Bottom right photo shows end result.

42. Adjust trim to fit snugly around the rear bar and the end surround.

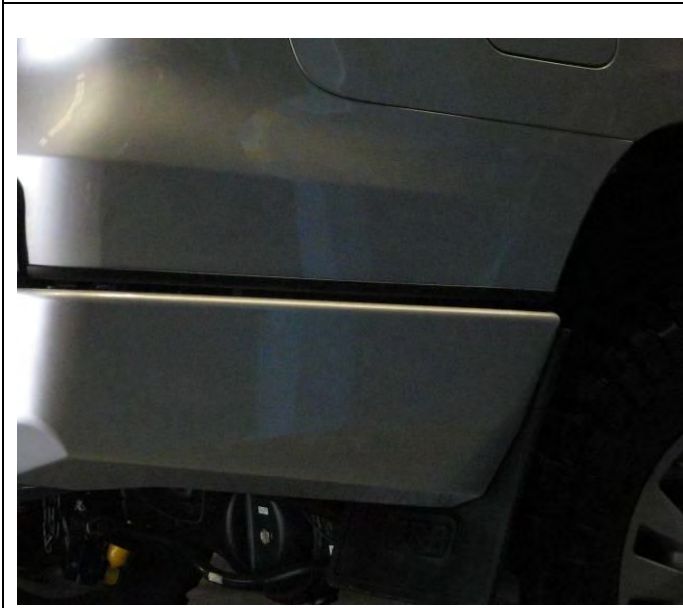
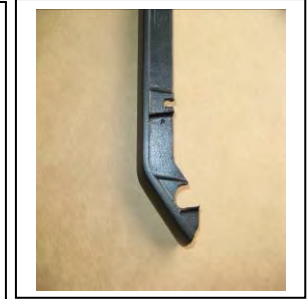
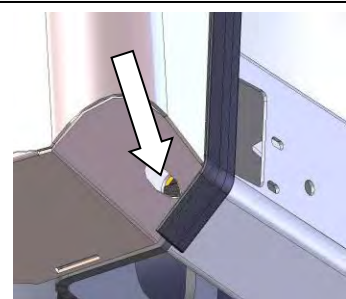

43. Align top face of end surround parallel with bumper of vehicle. Minimum clearance of 10mm must be maintained.

44. Starting in the top corner of the end surround and working backwards tighten all bolts.

A second person may be required to help keep the vertical trim fitting snugly and to ensure the end surround remains parallel to the body. Once this is done fit self adhesive trim to bottom edge of bumper.

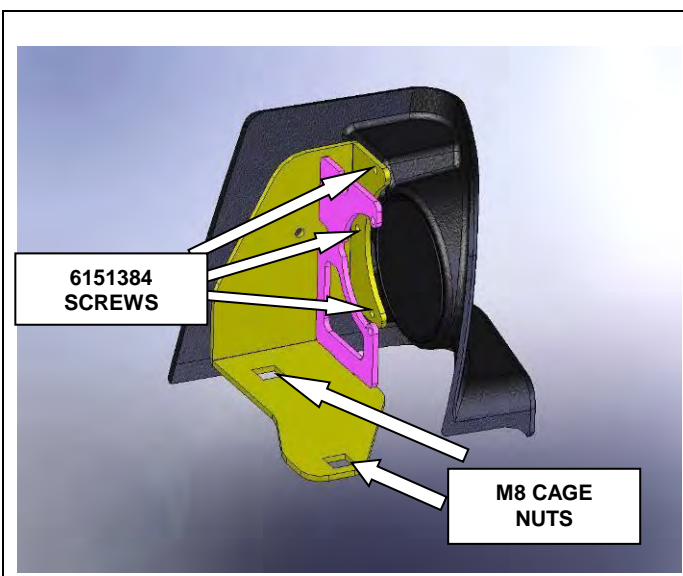

45. Fit reflector to fog/ reflector moulding. Fit M8 cage nuts to top surface of mount.

46. Fit self adhesive rubber to edge of mould as shown in photo (below right).

47. Place mould on top edge of bar and secure using two M8 x 25 bolts, spring washers and flat washers from underside of wing and through access holes in bar. Adjust for a snug fit on the vehicle bumper and allow clearance from tailgate.



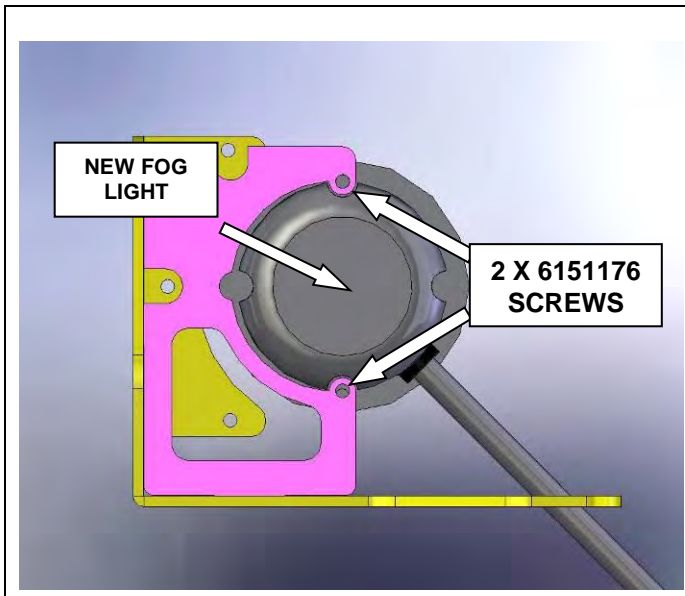

48. For vehicles equipped with factory fitted fog lights install kit 5715020. Remove centre piece of moulding by cutting with a 72mm hole saw using mould dimple on rear face as a centre point. Screw light to mount as shown and tap into original wiring loom by soldering extension provided in kit.



FITTING MUDDLAPS

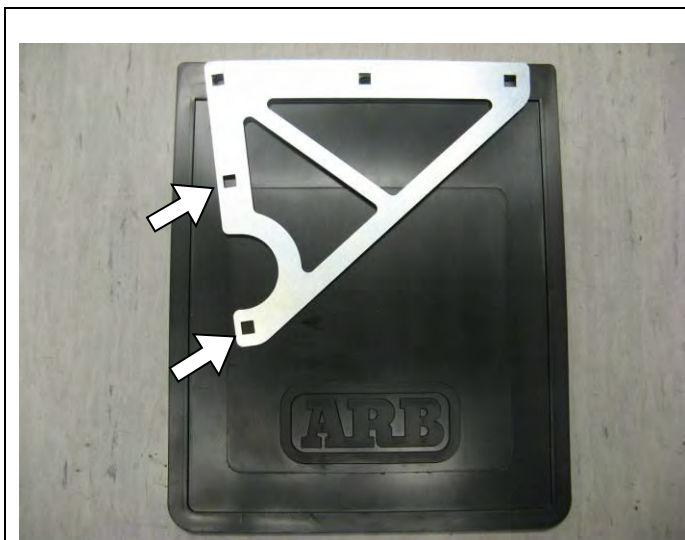

49. Place mounts on mudflaps as shown. On the ARB mudflap align the top holes of the mount with the top holes of the flap. Mark the two holes as shown in the photo and drill to 7mm. Install M6 cage nuts to holes in mount. LHS shown.

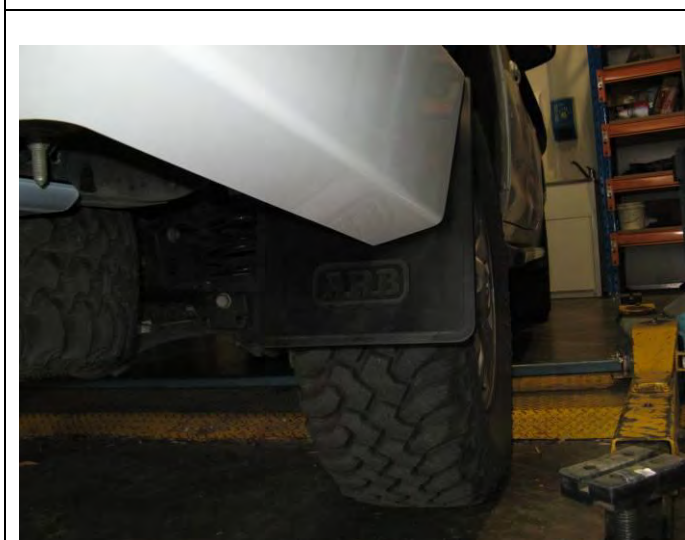

50. Place mudflap mount on inner surface of bar and mudflap on outer surface of bar and secure using black M6 bolts and flat washers.



51. Trim top of O.E mudflap level with top of rear bar and secure top section to bumper and body with original hardware.

FITTING TOP INFILL PLATE, ALUMINIUM STEP PLATE AND TRAILER PLUG

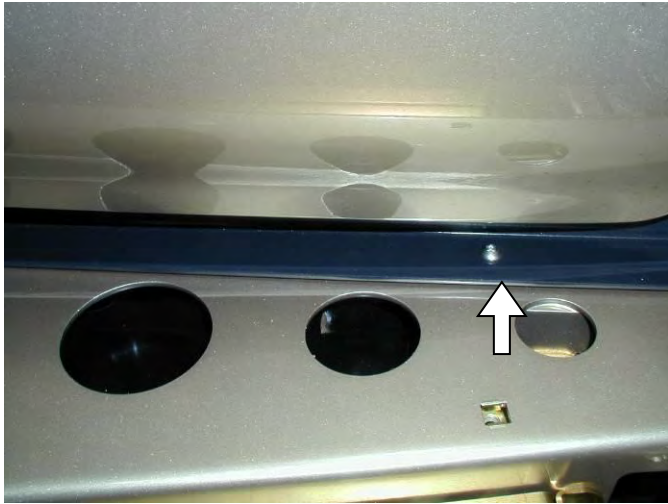

52. Using **M6 button head cap screws** fit top infill plate.

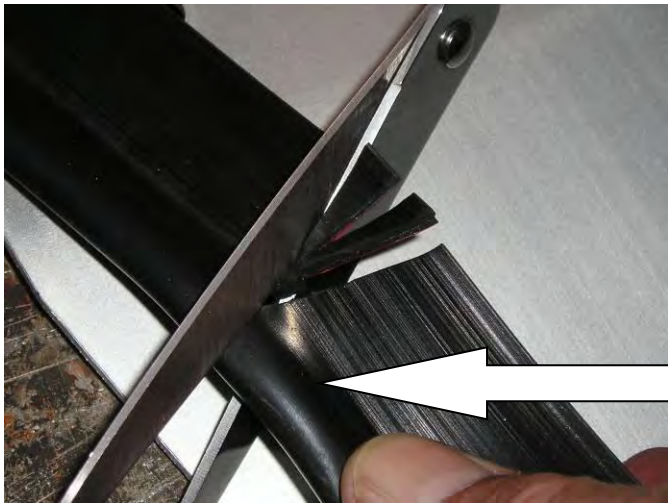

53. To fit rubber sealing strip to underside of aluminium step plate, lay strip on the underside of step plate and place so over hang is even on both ends. Using scissors, cut darts up to the bulb end of the rubber strip, so the strip can follow the front profile of the aluminium step plate.

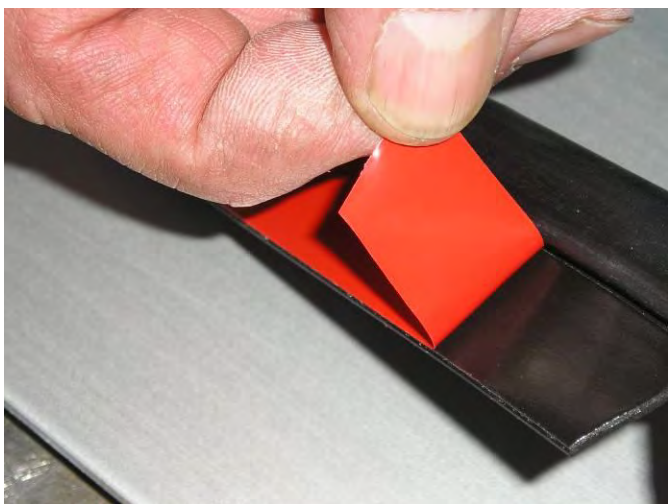

54. Carefully remove backing tape on the rubber strip and fit to step plate working from the centre outwards. Make sure rubber strip hugs the front edge of the aluminium step plate.

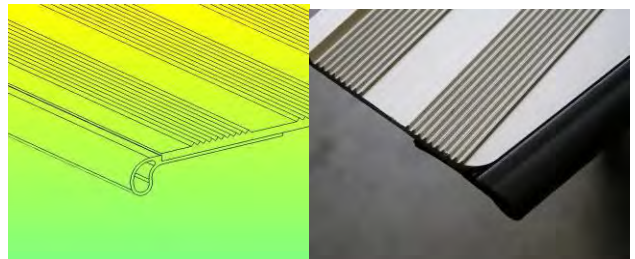

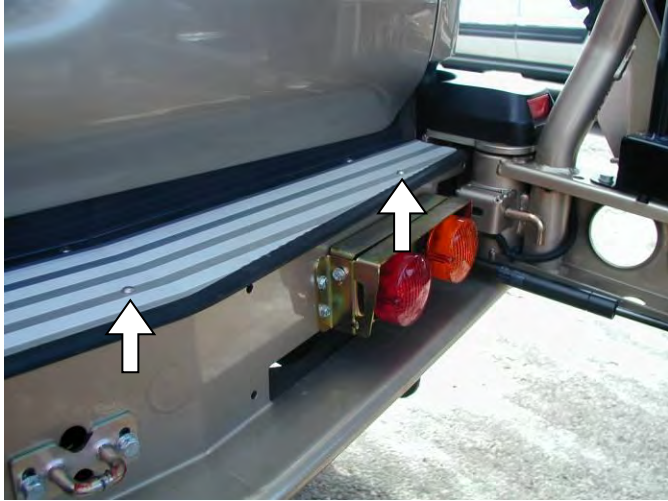

55. Using **M6 button head cap screws** fit aluminium step plate.

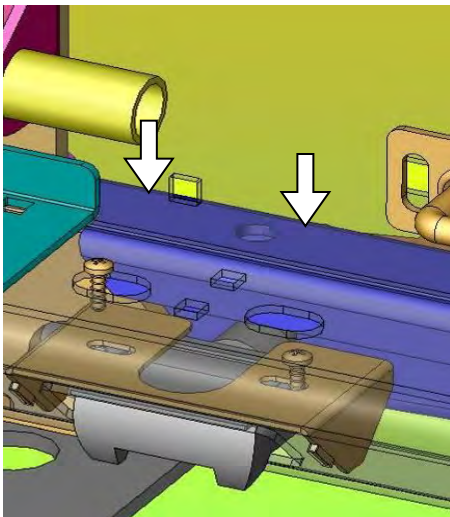

56. Fit trailer plug to recess using **M5 pan head screws** as shown by arrows.

For aesthetics and protection of the plug it is recommended that a flat type plug is fitted.

To fit alternate plugs an adaptor bracket (part number 5700090) is available. This is not supplied as standard with the rear bar kit.

TOW HITCH COVER PANELS.

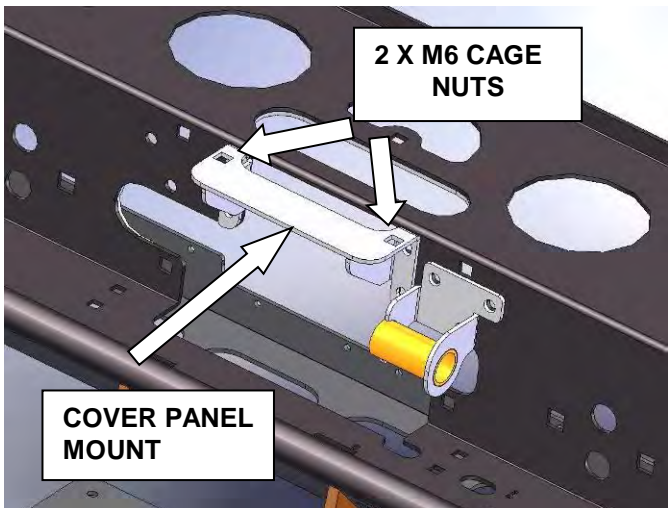

57. Install cover panel mount to cage nuts in bar using 4 x M6 x 15 bolts, spring washers and flat washers. Finger tighten only. Fit 2 M6 cage nuts to underside of mount. Close carriers if fitted and adjust mount to suit. Tighten all bolts.

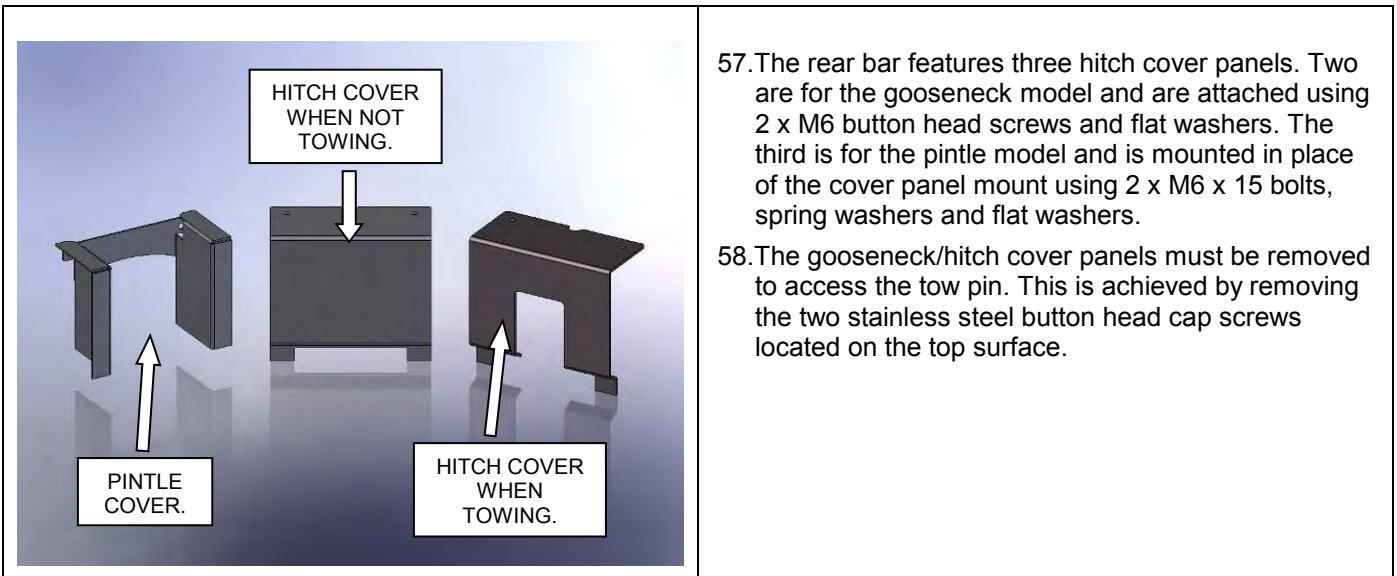

57. The rear bar features three hitch cover panels. Two are for the gooseneck model and are attached using 2 x M6 button head screws and flat washers. The third is for the pintle model and is mounted in place of the cover panel mount using 2 x M6 x 15 bolts, spring washers and flat washers.

58. The gooseneck/hitch cover panels must be removed to access the tow pin. This is achieved by removing the two stainless steel button head cap screws located on the top surface.



FITTING PROCEDURE



1. **Remove the tailgate bridging panel and set aside.**



2. **Carefully remove rubber trim surround being careful not to get any of the silicone on the vehicle interior. Once this is done remove the jack access panel and gently pry open the rear section quarter panel. Repeat for left hand side.**



3. **Using the double sided tape supplied in kit attach the module box to the quarter panel above the jack. NOTE: Clean area first with grease and wax remover. Attach the white earth lead to one of the M6 mounting points for the jack holder.**

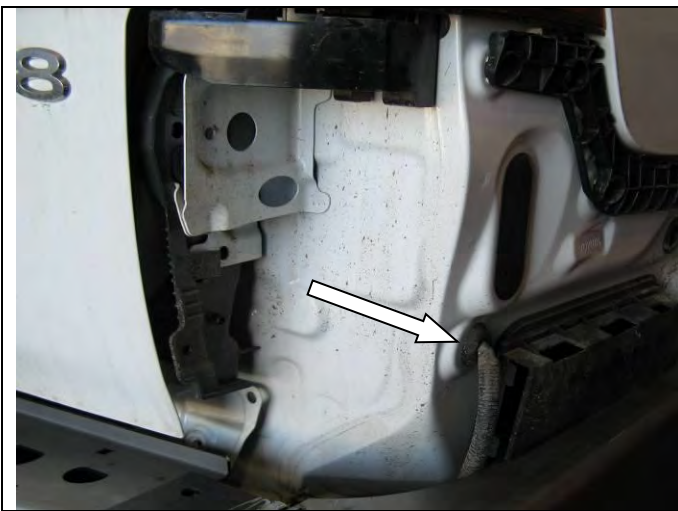

4. **Locate factory rubber grommet on drivers side and remove. Pass section of loom with grommet attached through this hole making sure grommet seals tightly.**



5. **Run wires along rear of bar to corresponding lights. License plate light section is long enough to cover either fittment on drivers side or passenger side. Cable tie excess behind bar. Run tow bar wires down to plug in bar and secure.**



6. **Run pick up wires for harness under bridging panel removed earlier to left hand side of vehicle. Secure with cable ties.**

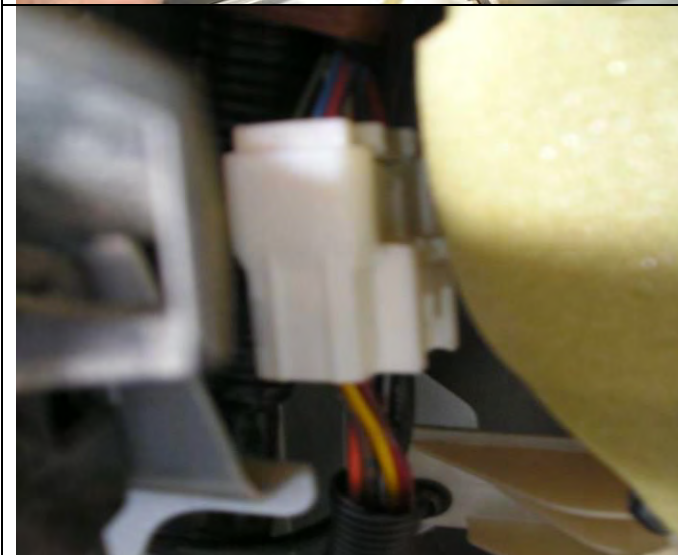

7. **Locate corresponding white male plug and attach loom. At this stage test that all lights are working and re-assemble interior.**