



# **FITTING INSTRUCTIONS**

## **ARB WINCH/NONWINCH BUMPER TO SUIT TOYOTA HJ100 IFS**

**PRODUCT No.** 3913140  
5100050 Top Tube Kit  
5100160 Buffer Kit – With hole (required when fitting Top Tube)  
5100170 Buffer Kit – With no hole

**Fitting Kit No.** 6172374

### **WARNING**

#### **FOR VEHICLES EQUIPPED WITH SRS AIRBAG**

**WHEN INSTALLED IN ACCORDANCE WITH THESE INSTRUCTIONS, THE FRONT PROTECTION BAR DOES NOT AFFECT OPERATION OF THE SRS AIRBAG.**

#### **TAKE NOTE OF THE FOLLOWING:**

- **THIS PRODUCT MUST BE INSTALLED EXACTLY AS PER THESE INSTRUCTIONS USING ONLY THE HARDWARE SUPPLIED.**
- **IN THE EVENT OF DAMAGE TO ANY BULL BAR COMPONENT, CONTACT YOUR NEAREST AUTHORISED ARB STOCKIST. REPAIRS OR MODIFICATIONS TO THE IMPACT ABSORPTION SYSTEM MUST NOT BE ATTEMPTED.**
- **DO NOT USE THIS PRODUCT FOR ANY VEHICLE MAKE OR MODEL, OTHER THAN THOSE SPECIFIED BY ARB.**
- **DO NOT REMOVE LABELS FROM THIS BULL BAR.**
- **THIS PRODUCT OR ITS FIXING MUST NOT BE MODIFIED IN ANY WAY.**

#### **OPTIONAL LIGHT SETS TO SUIT THIS PRODUCT:**

- ARB 6821201 Fog Light Kit Suit 3163015
- Up to IPF 900 SERIES FOG OR DRIVING LIGHT SETS

#### **Tools Required**

10mm, 18mm, 19mm, 21mm Spanners and Sockets. Phillips head screwdriver, Cordless Drill with Philips head tip (Optional).

#### **IMPORTANT**

- **This winch bumper is suitable only for Warn 9000lb and 9500lb winch only.**

USE	PART No	QTY	DESCRIPTION
MOUNT ASSY TO VEHICLE	6151257	2	BOLT M12 X 200mm
	4584298	4	WASHER FLAT M14
	4721469	2	TUBE PACKER
	5846282	2	CHANNEL PACKER
	4581050	2	WASHER SPRING M12
	6151189	2	NUT M12
	6151258	2	BOLT M14 X 80mm
	4581052	4	WASHER SPRING M14
	5846283	4	PACKER 10mm THICK
	3751812	1	MOUNT ASSY.
RUBBER EXTRUSION FITMENT	6821116	14	SQUARE PLASTIC PLUG
	6151176	14	SCREW SELF TAPPING 12mm 8G
	6191002	2	EXTRUSION
	3193616	2	MOUNT STRIPS
WINCH BUMPER TO MOUNT ASS	6151255	6	BOLT M12 X 40mm
	4581050	6	WASHER SPRING M12
	4581007	6	WASHER FLAT M12 LARGE
WINCH	4581044	4	WASHER 3/8"
BUFFER FITMENT (5100160 Required if fitting Top Tube)	6151128	12	NUT FLANGE M6
	3162153	1	BUFFER LHS
	3162154	1	BUFFER RHS
BUFFER FITMENT (5100170 Required if not fitting Top Tube)	6151128	12	NUT FLANGE M6
	3162471L	1	BUFFER LHS
	3162471R	1	BUFFER RHS
BUFFER LOWER FITMENT	6151128	5	NUT FLANGE M6
	3162155	1	BUFFER LOWER
TOP TUBE FITMENT	6151255	2	BOLT M12 X 40mm
	4581049	2	WASHER FLAT M12
	4581050	2	WASHER SPRING M12
	6131516	1	TOP TUBE
USE	PART No	QTY	DESCRIPTION
CONTROL BOX FITMENT	3756220	1	CONTROL BOX BRACKET
	6151017	2	BOLT M6 X 16MM
	6151128	4	NUT FLANGE M6
ROLLER FAIRLEAD FITMENT	6151255	2	BOLT M12 X 40mm
	4581050	2	WASHER SPRING M12
	4581049	4	WASHER FLAT M12
	6151189	2	NUT M12
WINCH COVER FITMENT	6151128	2	NUT FLANGE M6
	6151256	2	SCREW M6 S/STEEL BUTTON HEAD
	6191001	1	WINCH COVER EXTRUSION
	6521031	1	WINCH COVER

	4581304	2	WASHER FLAT M6 S/S
NUMBER PLATE FITMENT	6151017	2	BOLT M6 X 16mm
	6151128	2	NUT FLANGE M6
	6781408	1	TAPE DOUBLE SIDED
CB & HEADLIGHT WASHERS	3162152	2	PLASTIC PLUG DIA16
	3162159	2	PLASTIC PLUG DIA 22
WIRING	MD02	1	FOG LIGHT LOOM
	6821152	2	TURN SIGNAL / CLEARANCE LIGHT LOOM
	180701	2	SCOTCH LOCK
	UL002	1	LOOM
	180302	10	CABLE TIE
LIGHT SURROUND KIT	3163015	1	COMBINATION LIGHT SURROUND KIT
INDICATORS	6821151L	1	TURN SIGNAL / CLEARANCE LIGHT
	6821151R	1	TURN SIGNAL / CLEARANCE LIGHT

## ASSEMBLY SEQUENCE FOR WINCH BUMPER

1.



1. Disassemble the mount assy. from the winch bumper by removing the transit bolts and plated brackets.
2. Remove the bumper bar and grill.
3. Remove the cross member and tow brackets.  
See picture

2.



1. Insert the tube packers, one in each chassis arm. Line the bottom of the tube to the bottom hole of the chassis rail. Rest the top of the tube to the front of the chassis rail. The tube should be angled forward.

3.

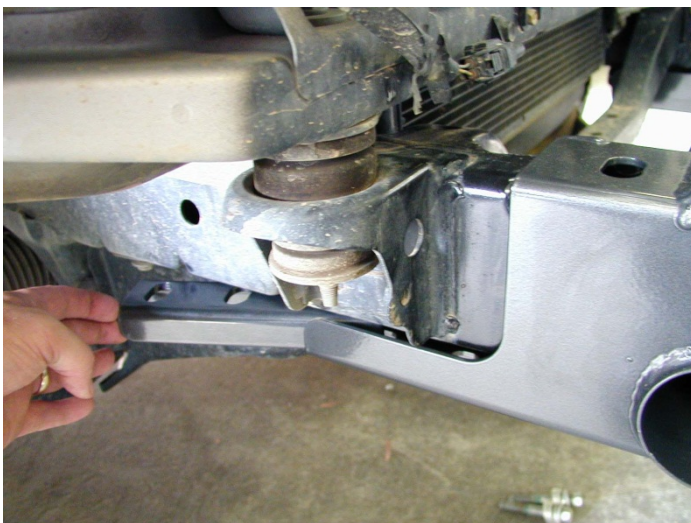

1. Slide the mount assy. over the chassis rails. Try not to shake the vehicle too severely as the tube packers may fall out of place.
2. Insert the channel packers from the rear. Make sure the hole correspond to the holes in the mount.
3. Push the entire mount as far back as possible.

## ASSEMBLY SEQUENCE FOR WINCH BUMPER

4.



1. Using a long screwdriver insert it through the bottom hole so it passes through the tube packer. This may require a visual check from under the vehicle to see the position of the tube.
2. Using the screwdriver twist around until the packer is inline with the top hole.

5.



1. Insert the M12 X 200mm bolt through the top hole using one of the 10mm thick packers. Push through while removing the screwdriver from underneath until the bolt locates right through

**NOTE:** If fitting to turbo diesel models the intercooler hose must be removed to insert the bolt. Refit the hose after bolt is fitted.

6.



1. Fasten the rest of the mount using :
  - 2 M14 bolts removed earlier from tow bracket
  - 2 M14 bolts from fitting kit
  - 4 M14 flat washers
  - 4 M14 spring washers
  - 2 10mm thick packers
  - 2 M12 nuts
  - 2 M12 spring washers

**NOTE:** Assemble with the tow brackets.

## ASSEMBLY SEQUENCE FOR WINCH BUMPER

7.

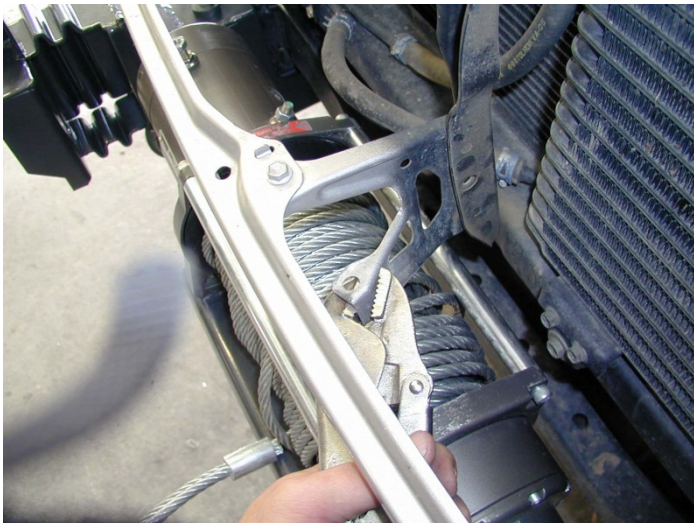

1. Using vice grips, multi grips or pliers bend back the bumper mounting arm approximately 30 – 40 degree's To clear winch bumper when assembled.

8.

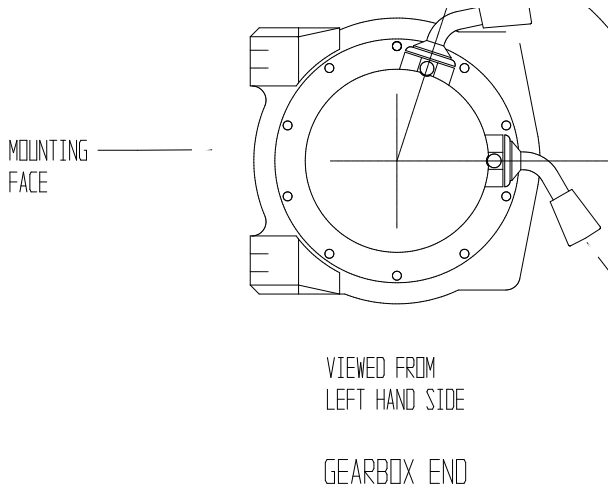

(If fitting with winch)

To place the clutch handle in a convenient location the winch gearbox must be rotated two hole spacing's.

1. Place the winch on its end and remove all gearbox bolts.
2. Gently raise the motor just enough to rotate it.
3. Do not completely remove the motor and avoid damaging the gasket.
4. Refit and tighten all bolts.

**NOTE:** Take care not to lift the assembly more than a couple of millimeters while rotating to the desired position to avoid un-meshing the gears.

9.

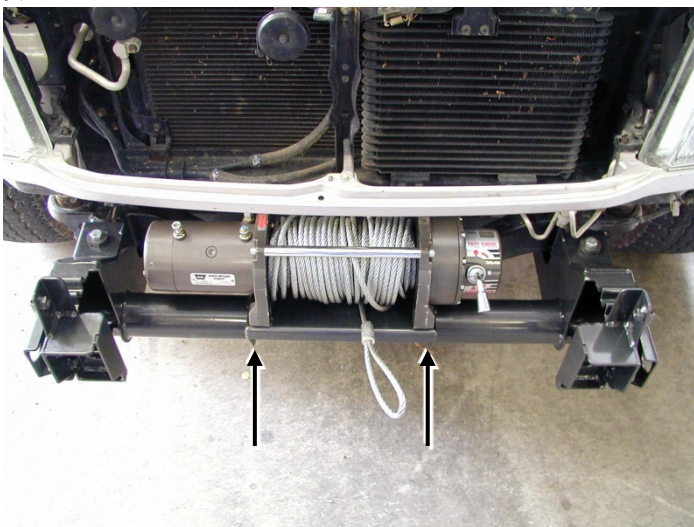

(If fitting with winch.)

1. Place the winch on the mount assy. as shown in picture.

Bolt from underneath using bolts supplied with winch. Refer to Warn installation instructions for correct procedure.

## ASSEMBLY SEQUENCE FOR WINCH BUMPER

10.

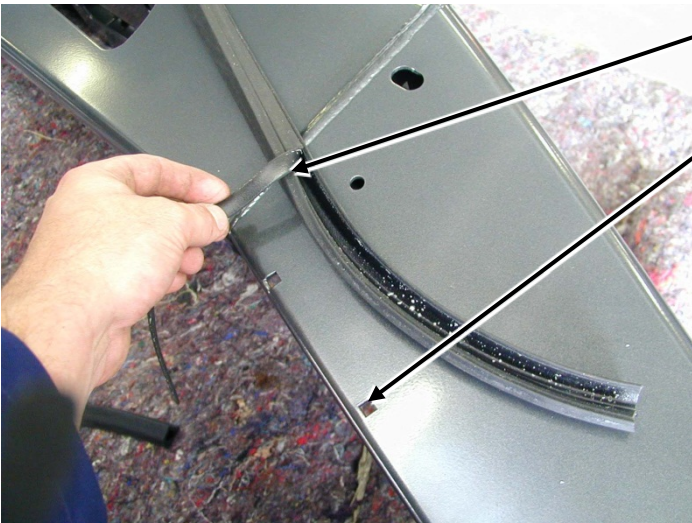

1. The rubber extrusions contain a support section to assist when moulding. Tear away this section by peeling at one end. Discard this section.
2. Insert the square plastic plugs into the square holes on the top face of the wing.

11.

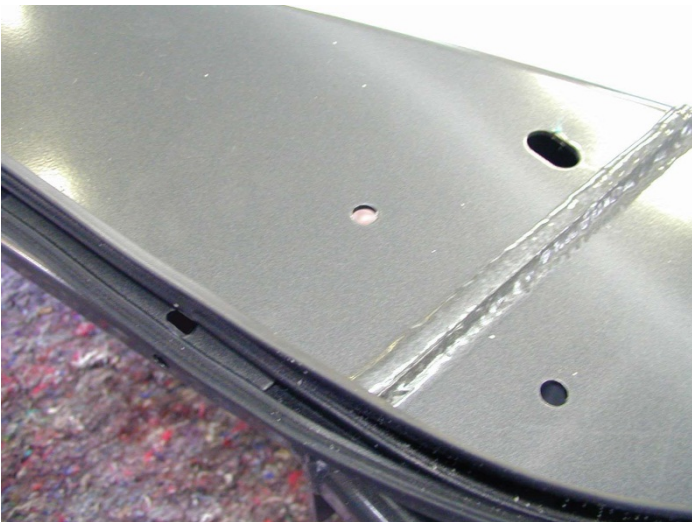

1. Insert the mount strips inside the channel section of the rubber extrusion. Make sure the flap section is on the outer side. Allow generous even amounts of excess at either end of the strip so that it can be trimmed later.

12.



1. Using a Philips head screw driver or cordless drill with a Philips head tip fix the extrusions to the top of the wings using the self tapping screws.

## ASSEMBLY SEQUENCE FOR WINCH BUMPER

13.



1. Using a sharp knife cut the excess rubber in line with the inside end of the wing. Only cut the inside excess, the other end will be cut when the winch bumper is fitted.

14.



1. With the aid of another person place the bar on the mount assy.

15.



1. Insert the M12 X 40mm bolts with the large plate washers and spring washers to finger tight.
2. Using another person position the bar to line up the rubber extrusion with the profile of the vehicle. Hold the wing of the bar so an even gap of approximately 15mm is achieved. Tighten bolts.
3. Repeat on other side.



## ASSEMBLY SEQUENCE FOR WINCH BUMPER

16.

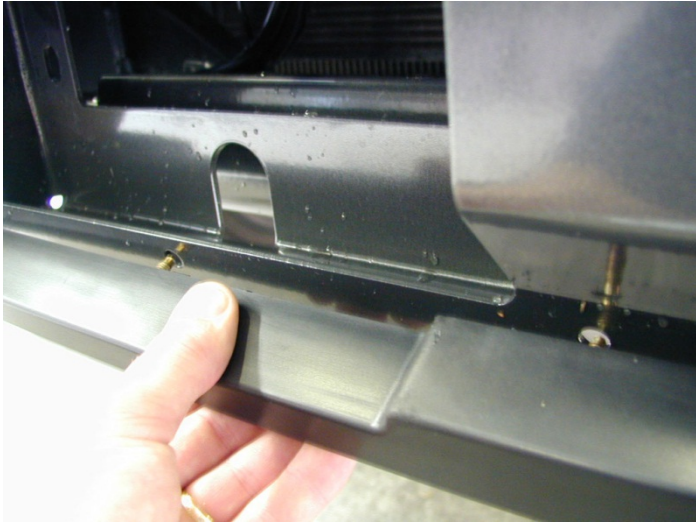

1. Position the lower buffer on the winch bumper and assemble using the M6 flange nuts.

17.



1. Fit the buffers. Buffer studs fit through the slots in the wings and the pan. Fasten using M6 flange nuts.

Note: This applies to both blank buffers and for those with the hole for optional frame.

**CAUTION: DO NOT OVER TIGHTEN THE M6 NUTS AS YOU RISK PULLING THE STUDS OUT OF THE BUFFERS.**

18.



### IF FITTING TOP TUBE

1. Push the tube through the holes in the top of the buffer and fix using the M12 X 40mm bolts washers and spring washers.

**NOTE:**

Torque these M12 fasteners to 44Nm only (Critical)

**If fitting the XP9.5 winch proceed to step 19. For any other winch, go to step 25.**

## ASSEMBLY SEQUENCE FOR WINCH BUMPER

19.



1. Remove the cover from the control box.

20.

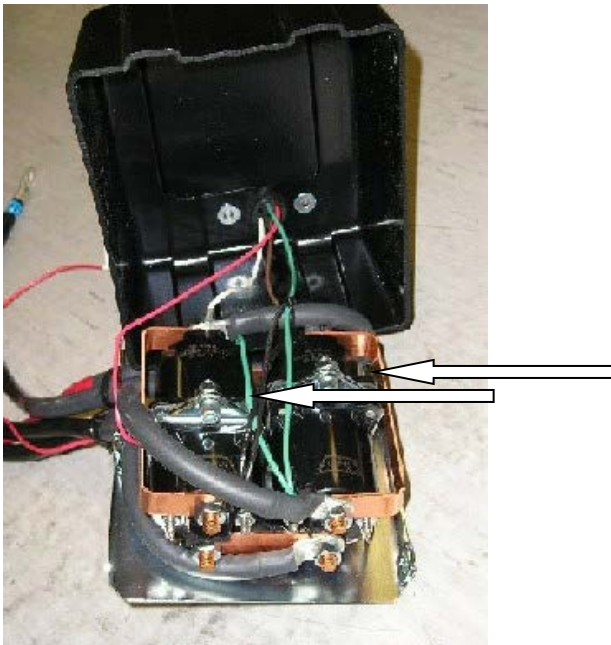

1. Remove the two cap screws, nuts and spacer washers that hold the four solenoids in place.

21.



1. Remove the four solenoids from the base of the control box using the copper bus bar as an aid and hold to one side.

## ASSEMBLY SEQUENCE FOR WINCH BUMPER

22.

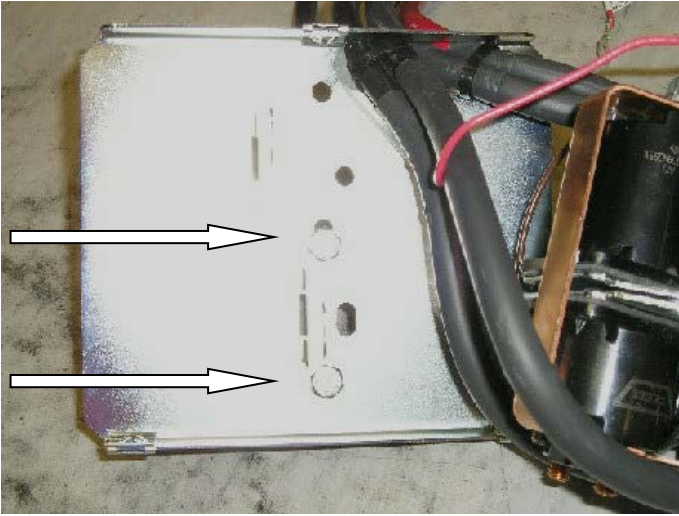

Before

1. Remove the two bolts in the base of the control box and reposition them into the more centralized holes

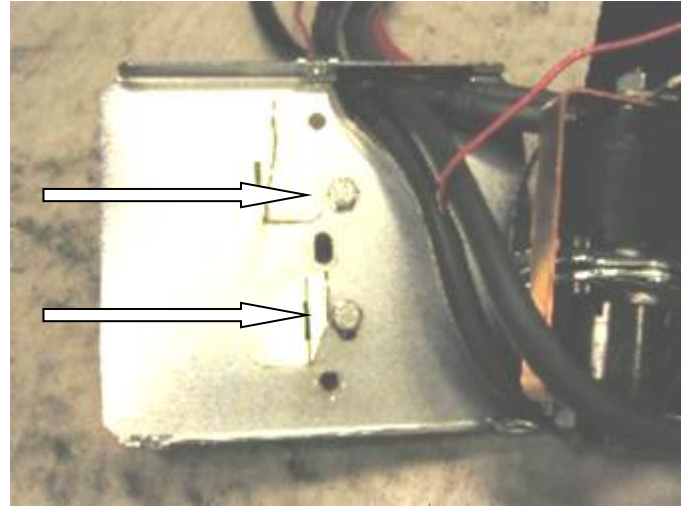

After

23.

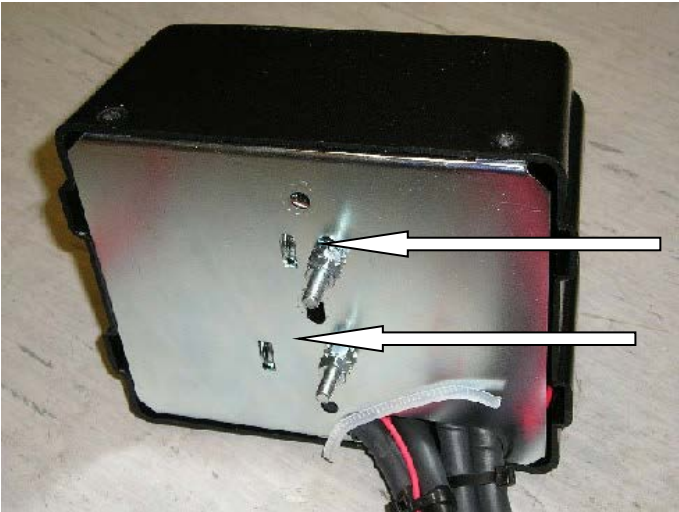

1. Place the 4 solenoids over the 2 metal stands that are facing upwards. Make sure they line up with the holes in the base.

24.



1. Replace the 2 cap screws, washers and nuts removed in step 20 above into original holes.  
2. Replace the black cover and refit the three cover screws (DO NOT OVER TIGHTEN)

## ASSEMBLY SEQUENCE FOR WINCH BUMPER

25.

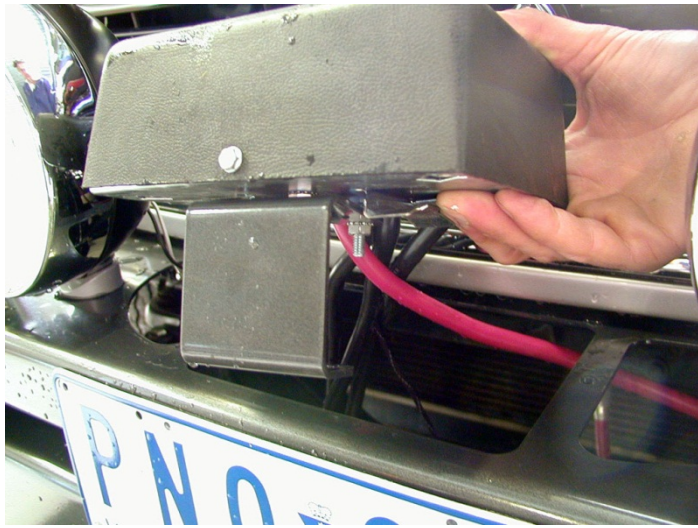

(If fitting with winch)

1. Assemble the control box bracket to the control box using M6 flange nuts.
2. Mount the control box to the bar using M6 X 16 bolts and M6 flange nuts.

26.



(If fitting with winch)

Bolt the roller fair lead to the winch bumper using the M12 X 40mm bolts, washers, spring washers and nuts.

27.



(If fitting with winch)

Feed the winch cable through the roller fair lead. Mount the hook to the end of the cable.

## ASSEMBLY SEQUENCE FOR WINCH BUMPER

28.



(If fitting without winch)

1. Wrap rubber extrusion around winch cover.
2. Place stainless steel washers over the winch cover fixing holes located on the top middle face of the winch bumper.
3. Place the winch cover on top of the winch bumper inline with the mount holes.
4. Bolt together using the M6 button head stainless steel screws and M6 nuts.

29.



**Fitting with winch**



**Fitting without winch**

(If fitting with winch.)

1. Peel off one side of the double-sided tape and adhere to the top rear side of the number plate. Note: Clean the adhering surfaces before applying tape with an alcohol solvent.
2. Peel off the other side of the tape and bolt to the winch bumper with the M6 X 16mm bolts and M6 flange nuts through the lower holes of the number plate.
3. Press firmly to the top of the number plate so the tape can properly adhere.

(If not fitting with winch.)

1. Bolt the number plate through the top holes using M6 X 16mm bolts and M6 flange nuts.
2. If desired the double sided tape can be used down the sides of the number plate.

30.

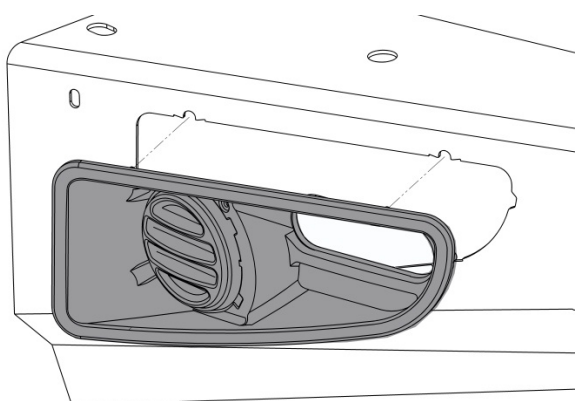

Assemble and install combination light surrounds (p/n 3163015) as per instructions no. 3786421 supplied with surround kit. Note: Optional fog lamps can be installed at this point as per fitting instruction no. 3783315 supplied with fog lamp kit no. 6821201. Wire the combination lamp to the vehicles indicator and clearance lamps. Caution: Cable tie all cables together and keep all cables clear of sharp edges and moving parts.

31.

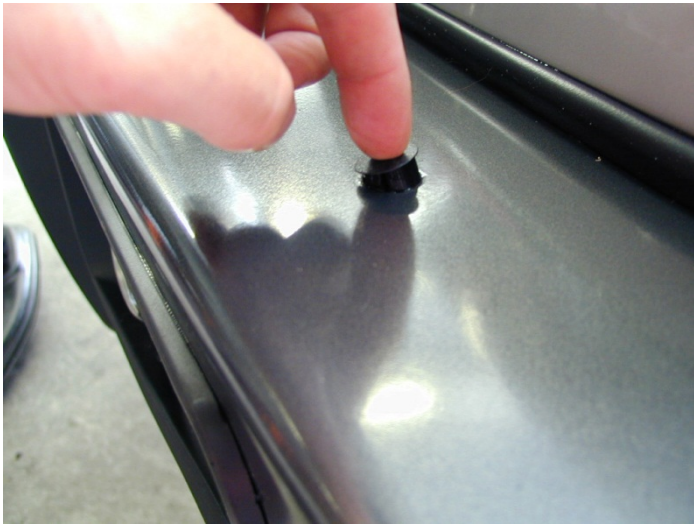

If fitted, headlight washers can be mounted through the Diameter 22 holes on the top face of the wing. Assemble using the existing mount clips. Two plugs are provided to cover the holes if there are no headlight washers on the vehicle.

There are two 16mm diameter holes located on the top face of the bar. If no CB aerials are fitted the holes can be covered with the plastic plugs provided in the fitting kit.

Place the ARB logo on the front face of the bar in the indentation.

Trim rubber extrusion at end of wing using a sharp knife. Cut on an angle to match the angle of wing and wheel arch.

32.

(If fitting with winch)

Connect the winch control box cables to the winch motor. Refer to the Warn handbook for additional information. Connect the long winch + & - cables to the vehicle after the bar is installed. Refer to the Warn winch manual for vehicle wiring instructions.

Ensure that these cables are installed well clear of sharp, hot or moving objects. Secure the winch cables to the vehicle and winch bumper with the supplied cable ties.

33.

Wire the fog lights to the vehicles parking lamps using the MD02 wiring loom, UL002 loom and two scotch locks. Ensure that these cables are installed well clear of sharp, hot or moving objects.

The fog lights can be adjusted to desired angles by the four adjustment screws located at the back of the light insert. When adjusting do not turn the screws further out from their original assembled position as they may be remove completely from the thread.

34.

Wire the clearance / turn signal lights to the vehicle wiring.

45.

Trim the extrusion between the winch bumper and vehicle using a sharp knife flush with the end of the wing.